

THE

KEY

1959



Love
Ronnie
Rezzo

Best of luck & success.

R. E. Murphy

God Bless You,
Always
Shirley & Mike

Good luck in your exams
and in the future years.

Mate friends.

Best of luck
in the future. May
God bless you.
Dorothy O'Keefe

To Harvey Jr.

It's so nice knowing
you in you. May you
succeed in everything you
do.
Love Always
Barbara Challenor
"Suzie"

Best of luck,
Don Ferguson

THE **KEY** to the Old West



presented by

"The Fifty Niners"

Benjamin Franklin High School

ROCHESTER, NEW YORK

Foreword

Nothing in the American historical experience is more inspiring than the saga of the great covered-wagon movement westward, over a century ago, when thousands of men and women risked their lives and endured formidable hardships to make a new homeland in the sun-drenched realm of the canyon and the cactus. The lives of these American pioneers were not glamorously exciting as they have often been portrayed by modern movies and novels; instead their existence was one of stark drudgery and ceaseless toil.

Nevertheless, despite the almost insurmountable obstacles in their path, the first western settlers had a saying, born out of the wisdom of their sweat and strain, which summed up what their harrowing journey had taught them. They used to say:

C	—"The		
L	—Cowards		
A	—Never		
S	—Started		
S	—And		
O	—The		
F	—Weak		
		1	—Died
		9	—Along
		5	—The
		9	—Way"

It is memory of these gallant people that we, the seniors of Benjamin Franklin High School, humbly dedicate our yearbook, never forgetting that the KEY to our understanding of their bravery and heroism is crystallized in that glorious eleven word sentence out of our own past.

OUR 1959 Key PRAIRIE SCHOONER

FACULTY

Page 5

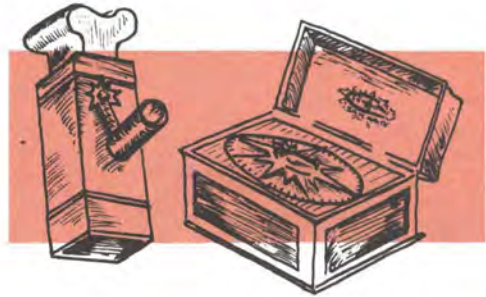

SENIORS

Page 15

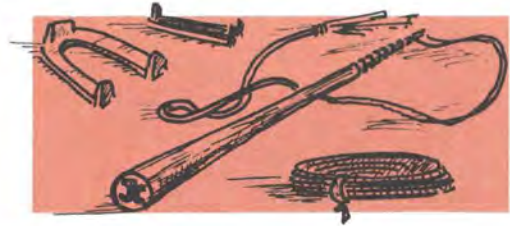

ACTIVITIES

Page 53

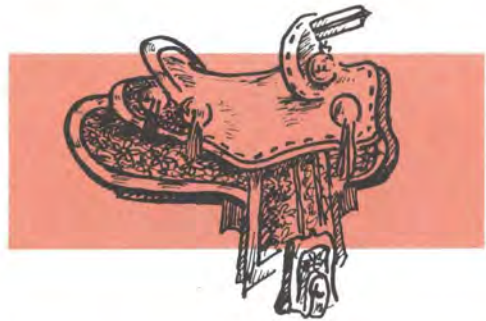

ADVERTISERS

Page 95



J. GILOTTI

Our Frontier



We, the Senior Class of 1959, are proud to offer a special salute to the head of our "army"—to you, Mr. Sabin, a trailblazer and a pathfinder, whose sterling pioneer qualities of integrity, industry and everlasting endurance will long remain our inspiration, after our youthful trumpets have been muted and after the dust has settled and the sun has passed over the familiar Franklin foliage of our lives.



MR. WILLARD A. SABIN
Principal

"The Wagonmaster"



"Roll Out! Roll Out!"

All trains to the West were governed by the wagon-master or captain, who, as commander of the caravan, was in sole possession of the compass which provided the necessary directions for the hazardous journey. Often nicknamed "Wagon Jack", he, as "King of the road," selected camp sites, assigned trail scouts and guards for night duty, and made certain that the work of the train was done each day.

The stock was always watered, fed, and guarded at night, and guards were under the direct guidance of the wagon-master.

Our faculty, like the eternally vigilant wagon-master, is one of kingly courage, experience, and wisdom. As guardians of our scholastic schooner, they, in their own wise way, defend us from the Indians of ignorance and the frontiers of folly, feed our student stock with the food of knowledge, and keep our KEY KARAVAN rolling relentlessly toward the green fields and sunny horizons of successful living.



Miss Catherine Sullivan
Vice Principal
in Charge of Instruction

Vice Principals

J. L. Lowell

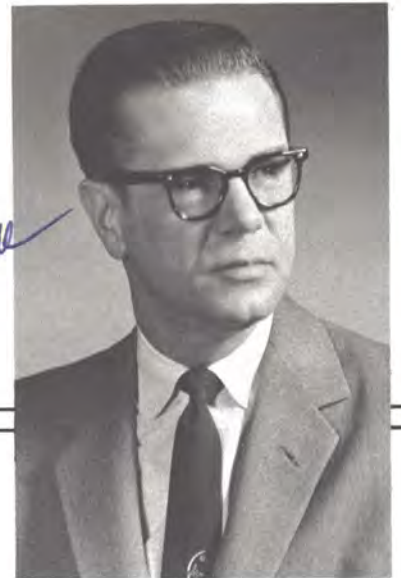

Mr. Julian L. Lowell
Vice Principal
in Charge of Pupil Services



Department Heads

Dorothy Martens

Mrs. Katherine Connell, for English; Miss Emily Thompson, for Business Education; Miss Catherine Sullivan, Vice-Principal in charge of Instruction; Mr. Carl Chamberlin, for Health and Physical Education; Mr. Domenic DeFrancesco, for Foreign Language; Mr. Bernard Greenberger, for Occupational Education and School Work Program; Mr. Raymond Iman, for Social Studies; Mr. H. Carlisle Taylor, for Mathematics; Mr. Matthew Lyders, for Music; Mr. Harold Miller for Science; Mr. Elston Yaeger, for Practical Arts.

Mr. Julian L. Lowell, Vice-Principal in charge of Pupil Services; Mr. Merl Ringwood, Boys' Adviser for grades 8, 9; Mrs. Dorothy Redding, Girls' Adviser for grades 8, 9; Mr. Charles N. Stalker, Boys' Adviser for grades 10, 11, 12; Miss Dorothy Martens, Girls' Adviser for grades 10, 11, 12.

Advisers





Mrs. Shirley Spitz
Nurse



Mr. Harold Schwartz
Psychologist



Mrs. Litwin
Attendance Officer



Mrs. Eleanor Burgess
Speech Therapist

Special Services

Counselors

Sitting: Mr. Robert H. Smith; Miss Anna Marie Rauber; Miss Patricia Carnahan; Mr. Julian Lowell, Vice-Principal in Charge of Pupil Services. **Standing:** Mr. Pincus Cohen; Mr. Hyman J. Kaplan; Mr. Donald Rahtjen.



Miss Edna Bayer; Mrs. Marge DeJohn; Mrs. Doris Fuller.

Librarians

Grace M. Knitter

English

*Best wishes
to a good faculty!
F.R. Proud*



Seated: Mr. Dennis McGuire; Mrs. Grace M. Knitter; Mrs. Mona McGurk; Mrs. Sharon Fero; Miss Agnes Kellner, Mrs. Katherine Connell, head; Mrs. Marian Hoover; Miss Johanne Pouliot; Mrs. Marcia Summers. **Standing:** Mrs. Mildred Sidler; Miss Lois Rowley; Mr. Richard McHugh; Mr. Philip Strauss; Mr. William Callahan; Mr. Norman Gebauer; Mr. George Sherwood; Mr. Charles Griffith; Mr. Joseph Gullo; Mr. Ronald Proud. **Absent:** Mrs. Dorothy Fraser; Miss Miriam Levin; Miss Marilyn Songer; Mrs. Noreen Bride.

Foreign Languages



Sitting: Mr. Domenic DeFrancesco, head; Mrs. Belle Sherman; Miss Irene Hess. **Standing:** Mr. Ronald Masters; Miss Agnes Peterson; Mr. Donald Rahtjen; Mr. Pincus Cohen.

Mathematics



Sitting: Mrs. Clara Bode; Mr. H. C. Taylor, head; Mrs. Lawana Nofzt; Mrs. Margaret Howe; Mrs. Stella Nicoletti.
Standing: Mr. James Sims; Miss Marion Tuttle; Mr. Gilbert

Crane; Mr. Ronald Migliore; Mr. Frederick Hawke; Mr. Albert Whitaker; Mr. Raymond Boland.

Science



Sitting: Mr. Robert H. Smith; Miss Ruth Steward; Mrs. Edna Daly; Mrs. Ruth Smith; Mr. Harold H. Miller, head; Miss Nancy Wilber. **Standing:** Mr. Ralph Lomio; Mr. Hyman

J. Kaplan; Mr. Charles Perham; Mr. Calvin Cornell; Miss Esther Callahan; Mr. Anthony Betten; Mr. James Vaiana; Mr. Louis Frasca; Miss Phyllis Williams.

L.B. Leggett

Business Education



Sitting: Miss Joyce Masters; Mrs. Elizabeth Palmer; Miss E. Landrio; Miss Anna Marie Rauber; Mrs. Laura Smith; Miss Emily Thompson, head; Mrs. Abrona Batz; Miss Eleanor

Ratcliffe. Standing: Mr. Leon Leggett; Mr. Gerald Mousso; Mr. George Weber; Mr. John Kelly; Mr. Benjamin Lipson; Mr. Roy Erdman.

Social Studies

Good luck & Bukowski

*Reckless to a formal
sit. Frank and I want
young lad
with red hair
Disclaimed*



Sitting: Mr. Raymond Iman, head; Mrs. Aderf Atkinson; Miss Teresa Leene; Miss Barbara Moore; Mrs. Helen Martin; Mrs. Reveira Wilcove; Mrs. Dorothy Loncle; Mrs. Helen Villone; Mrs. Doris Fuller. **Standing:** Mr. Russell Brigandi; Mr.

Ernest Du Bois; Mr. John Clark; Mr. F. A. Chapell; Dr. Charles J. Meder; Mr. Edward D. Mills; Mr. Frank Hasic; Mr. Frank Bukowski; Mr. Harold Swarhout; Mr. E. F. Quinn; Mr. Eugene MacConnell.

*Bob Hishon
Practical Arts
Schlager*



Sitting: Mr. Joseph Ruffino; Mrs. Edith Dennison; Mrs. Fanny Emery; Mrs. Mary King; Mrs. Elizabeth Ringwood; Mr. William Read. **Standing:** Mr. Ward Donahue; Mr. Elston Yaeger, head; Mr. Arthur Mohr; Mr. William Schlag-

eter; Mr. James Finnegan; Mr. Joseph Kaiser; Mr. Alfred Marini; Mr. Robert Westover; Mr. Samuel Saunders. **Absent:** Mrs. Phyllis King; Mr. Howard Eckert.

Fine Arts

Mr. R. Nelson. **Missing:** Mr. E. Maurer; Miss M. Tuthill.



Good luck
 Good wishes!
 Good Good wish!
 miss
 Shek



Health and Physical Education

Love of work
 Miss Powers



Front: Mr. Carl Chamberlain, head. **Sitting:** Mr. Harold Roche; Miss Edna Snow; Miss Mabel Rodman; Mr. Burns Beach; Mrs. Helen Kessler. **Standing:** Mr. Hobart Hoff; Miss Lillian Streb; Miss Emelda Williams; Mr. Byron Sullivan; Mr. George Hart; Mr. William Graf; Mr. Mauro Panaggio; Miss Deborah Powers.

Occupational Education and School Work Program



Sitting: Miss Ruth Klee; Miss Madeline Mannella; Mrs. Genevieve Cupolo; Mrs. Eleanor Edelstein; Mr. Kenneth Hed. **Standing:** Mr. Frank Stein; Mr. William H. Williams; Mr. Bernard Greenberger, co-ordinating teacher; Mrs. Catherine Eddy; Mr. Loftus C. Carson. **Absent:** Mrs. Etta Pease.



Mrs. Florence Ducat; Miss Marcia Mirch; Mrs. Mona Malanga; Miss Nancy Wildzunas.

Office Staff



Seated: Mr. Eugene Healy; Mr. Larry Irwin; Mr. Herman Wisotzke; Mr. Al Kaplin.

Maintenance



Lunchroom Staff

Miss A. Shaw; Miss B. Matczak; Miss T. Espe; Miss S. Knapp; Miss L. Heintz; Miss V. Szczepanski; Miss I. Schlegel; Miss L. Walker.

A List of Typical Provisions

Carried by Franklin's "Fifty Niners"
 And Joyously Bequeathed To Our Lunchroom, Office and Maintenance Staffs
 In Order That They May Keep Future Pioneers As Well Fed And
 Equipped As We Have Been During Our Hazardous Travels Along "The
 Wilderness Road" From Miss Wildzunas' Way Station to
 Mrs. Burdick's "Butte."

Flour—600 pounds
 Sugar—75 pounds
 Cured Hams—150 pounds
 Ground Coffee—30 pounds
 Bran—3 boxes
 Soda—4 pounds
 Salt—25 pounds
 Dried Fruit—3 bushels
 Dried Beans— $\frac{1}{2}$ bushel
 Corn Meal—2 bushels
 Tin dishes and spoons
 Iron Pot
 1 Hand Saw
 200 Sheets of Goat Parchment

Pilot Bread—70 pounds
 Vinegar—3 kegs
 Tarpaulins
 Rope
 Nuts and Bolts
 Wagon Bows
 Wagon Tongue
 Ox Yokes
 Axe
 Shovel
 Tent
 Seed Potatoes
 2 Tar Boxes
 2 Barrels of Gooseberry Ink

Ginger
 Molasses
 3 Sharp Knives
 Water Keg
 Churn
 Dutch Oven
 Iron Skillet
 Wool Blankets
 Ammunition
 2 Cows
 6 Sheep
 Auger
 Wagon Jacks
 4 Quill Pens



"Come my tan-faced children,
Follow well in order, get your weapons ready,
Have you your pistols? have you your sharp-edged axes?
Pioneers, O Pioneers!"

WALT WHITMAN

The Muleteers

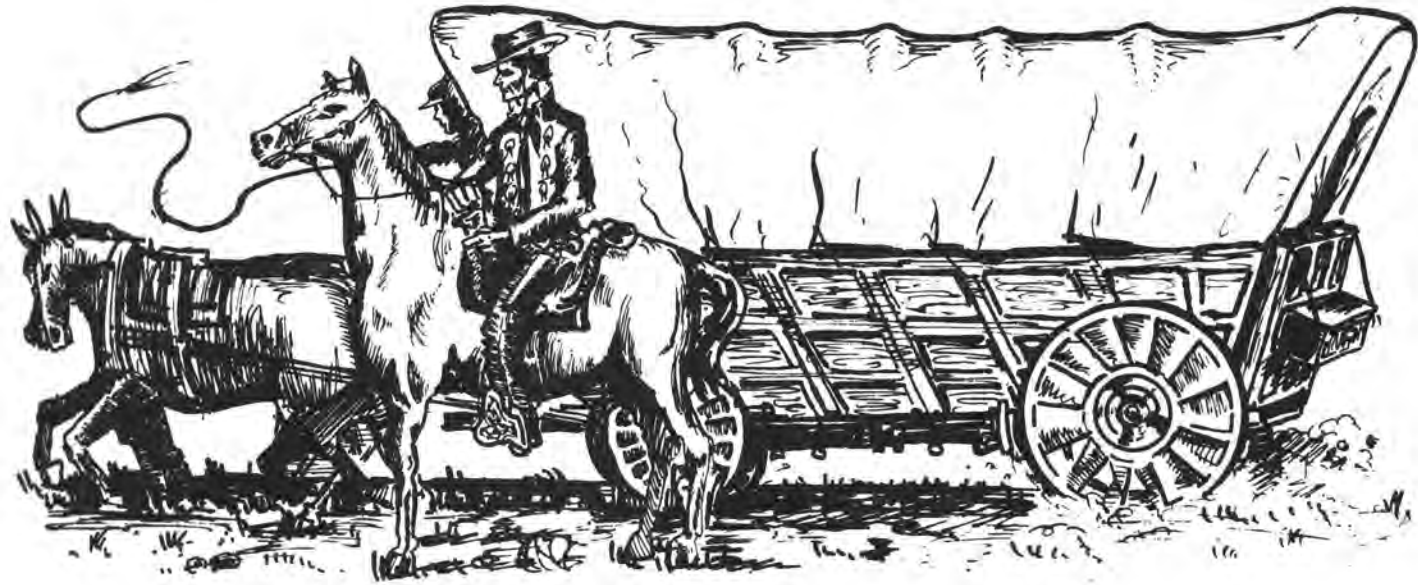

"Mule HO! Mule-AH!"

The most important rule for any caravan was to "keep moving." As the great wagon pilot, Marcus Whitman, once said: "The one rule of the road that must never be broken is travel, travel, TRAVEL; nothing else will take you to the end of your journey; nothing is wise that does not help you along; nothing is good for you that causes a moment's delay."

This constant travel, in spite of hunger and fatigue, in spite of broken wagons and lame animals, was performed by the muleteers or drivers, who, with bullwhips in hand, yelled "Mule ho! Mule-ah!", as the long train moved inexorably across the grassy plain.

Likewise, our seniors—those traveling teamsters—have successfully forded the rivers of reason and avoided the quicksands of Quakerland in "whipping" all obstacles to the completion of their memorable journey over the treacherous terrain of Franklin's frontier.

CLASS OF 1959

ADVISERS



Mrs. Elizabeth Ringwood
Adviser



Mr. George Weber
Adviser



Peter Palermo
President

OFFICERS



Tom Lupo
Vice President



Marilyn Nolan
Secretary



Willard Sproule
Treasurer



Barbara Buckler
Girls' Social Chairman



Roger Siekierski
Boys' Social Chairman



SENIOR CLASS COUNCIL

Front Row: C. DiPrima; E. Bush; R. Siekierski; T. Lupo; P. Palermo; M. Nolan; B. Buckler; J. Rosen; R. Stagliano. Second Row: I. Cresov; S. Eckrich; A. Pecoraro; T. Panzarella; E. Gugino; M. Iwankiw; J. Ades; N. Pulvino; E. Rimmeli. Third Row: J. Andreano; D. Cross; F. Feola; S. Gallant; J. Barker; N. Pica; G. Koldan; D. Simon; R. Nash; G. Chidsey; H. Yeakel; B. Driessler.



JAMES H. A. ABEL
218 Hollenbeck St.



MICHAEL EDWARD ADAMS
62 Oakman St.



JUDITH ANNETTE ADES
46 Rosemary Dr.

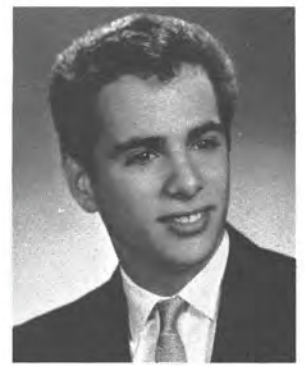

FREDERICK J. ALFIERI
18 Mark St.

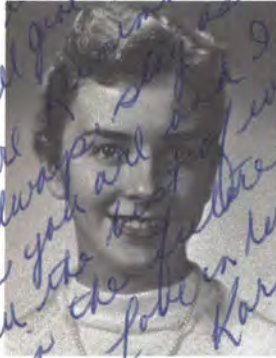

KAREN W. ALLEN
16 Lochner Pl.



FRANCES ALOJ
300 Marne St.



SALVATORE A. ALONGI
46 Harvest St.



JOHN R. ALTAVENA
112 Rexford St.



DAVID BARRY ALTMAN
109 Rauber St.



FRANK WILLIAM AMAN
327 Shelford Rd.



JUDITH A. ANDREANO
4 Heberton Rd.



RICHARD WALTER ANDRUS
85 LeFrois St.



DOUGLAS G. ANNE
99 Avenue C



CAROL ANN ANTONITTO
40 Helena St.



DIANE N. ARENA
372 Grantham Rd.



LOUIS CHARLES ARENA
166 Lincoln St.



HELEN ARMBRUSTER
200 Norton St.



EILEEN HELEN ARONOW
7 Jewel St.



JOEL MICHAEL ATIAS
83 Avenue C



RONALD GORDON ATWATER
134 Grafton St.



JUDITH CHARLOTTE AUER
113 Sydenham Rd.



SUSAN LOUISE AVERY
94 Hoffman Rd.



ILONA K. AVIZIENIS
97 Barberry Ter.



CHRISTINA BACHNER
248 Avenue A

"All the pulses of the world,

with the Western movement beat,

steady moving to the front,

Pioneers!



LINDA R. BAKER
194 Avenue E

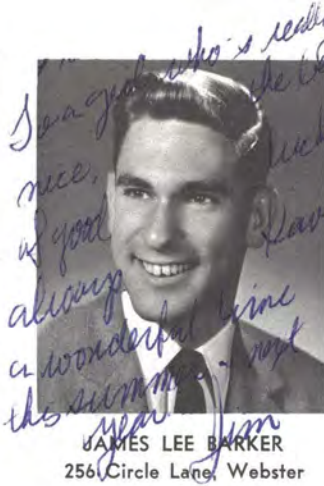

JAMES LEE BARKER
256 Circle Lane, Webster



JOANNE JEAN BARNASH
297 Hartsdale Rd.



PRUDENCE E. BARRALE
245 Brookdale Pk.

We've been friends for a long time. Falling in they beat for us, friendship will always be. Best of luck always. Remember me always. Holding single or together, Linda



FREYA ARLENE BASKIN
50 Sullivan St.



WILLIAM JOSEPH BECKER
301 Weyl St.

all for us,

O Pioneers!"

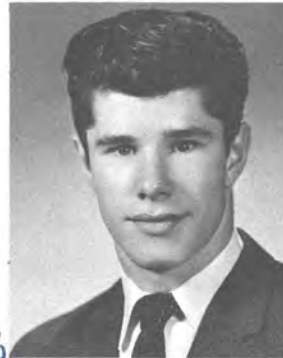

HAROLD ERWIN BECKWITH
423 Remington St.



MARY W. BENESCH
227 Ashwood Dr.

I want to wish Walt Whitman all the luck in the world. You're just a sweet kid



HERBERT M. BENTLEY
101 Dickinson St.



CARL MICHAEL BERGER
499 Clifford Ave.



DAVID ISAAC BERLOWITZ
167 Norton St.



HOWARD L. BERNSTEIN
287 Versailles Rd.



ALLEN W. BROWN
78 Lill St.



REXFORD GLENN BROWN
23 Fawn St.



LUTHENE BRUINSM
52 Homewood Lane



BARBARA LEE BUCKLER
50 Malling Dr.



ALAN F. BURGESS
89 Cliffordale Pk.

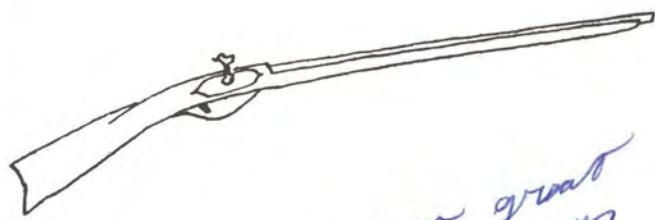

It was great knowing always love you



SHIRLEY ANN BURGETT
1115 Monroe Ave.



LINDA MARGARET BURNS
2095 Titus Ave.



Dear Irene, Well, once again, I wish you had a lot of luck. Dr. has known me for a long time. Please love you are change, C. Paine



ELAINE JUDY BUSH
250 Tarlington Rd.



BONNIE MARIE BUTLER
188 Peart Ave.



LINDA CAROL CALIRI
1922 Norton St.



ELAINE S. CAMMARATA
1953 N. Goodman St.



PATRICIA LEE CAMPBELL
52 Gilbert Dr.



JOSEPH A. CANZONERI
65 Rustic St.



ANTHONY J. CAPPADONIA
149 Blakeslee St.

*It's been
a ball in
the room for 5 yrs.
I hope I see you
after graduation
(Dad)*



RUSSELL A. CAPPELLINO
95 Norran Dr.

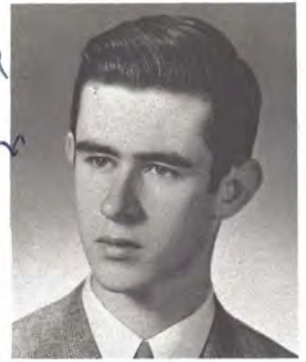

JOSEPH HUNTLEY CASEY
330 Walzer Rd.



BARBARA A. CAVALLARO
144 Randolph St.



MARIO A. CERAMI
132 Nichols St.



KAREN CERASANI
58 Tottenham Rd.



LAWRENCE H. CHAIT
114 Thomas St.

*This past
year has really
been an experience
working with one
of the
V.P.'s men
you
only the
best in
Good luck!
Love,
Reesa*



REESA ROCHELLE CHASKY
217 Conkey Ave.



SHIRLEY CHERKASKY
33 Gorham St.

*Best of luck
and success in the
future. Luck Always!*



GLENN CHIDSEY
7 Edgeland St.



JOHN CICIOTTI
180 Burwell Rd.



JACQUELINE LEE CIRA
635 Helendale Rd.

*I love you
What a great
girl you are
I will always
love you
Love
L. Cira*



MARGUERITE J. CIURCA
53 Hoff St.



THOMAS PAUL CLARKE
1252 Clifford Ave.



ELEANOR V. COHEN
127 Collingwood Dr.

*I love you
I hope
you will
stay in
this
space.
Small
so turn
back.
Love,
Eddie*



CAROLE ANN COLEMAN
302 Orland Rd.

*I love
you
Best
friend
Love
Carole*



CAROL ANN COPPETA
31 Newcomb St.



PHYLLIS ANNE COSTA
16 Yates St.



PAULINE A. COSTANZA
6 Marjhou St.

*I love
you
Love
Pauline*



IRENE JOYCE CRESOV
786 Clifford Ave.



LEONARD MICHAEL CRINO
31 Clairmount St.

*I love
you
Best
friend
Love
L. Crino*



DAVID LAWRENCE CROSS
554 Conkey Ave.

*I love
you
Best
friend
Love
D. Cross*



MARIE E. CURATALO
41 Hollister St.



RICHARD ALAN CUSHMAN
136 Navarre Rd.



SANDRA ANN DEAN
475 Albemarle St.



DIANE LEE DeJOHN
106 Waring Rd.



DONALD J. DELLA VELLA
5 Woodland Cir.

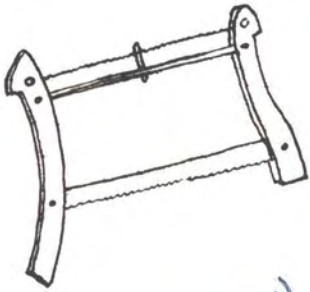

ROCHELLE ANN DeMAYO
60 Requa St.



RICHARD A. DeNINNIS
228 Herald St.



THOMAS JAMES DENT
597 Scio St.

Love + Luck
Tom Dent
(Mr. Esquire)



ANTONENA DENYSENKO
39 Bleile Ter.



LINDA LEE DeWITTE
35 Garford Rd.



CARMEN I. DIAZ y NEGRÓN
12 Almira St.



ANNETTE S. DICHIARO
134 Rohr St.



WINNIE A. DICK
1339 N. Clinton Ave.



ELEANOR P. DICLEMENTE
58 1/2 Lowell St.



CAROL R. DIMORA
24 Clairmount St.



RICHARD DIMURO
85 Sunrise Cres.



DAVID A. DIGUARDI
200 Norran Dr.



CHARLES BANTO DIRIMA
262 Clairmount St.



EDWIN LOUIS DIXON
75 Lowell St.

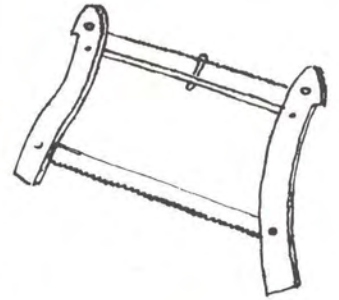

MARLENE DOKTOR
8 Mauder Pk.

It has been fun hanging you and being around at your locker. All kidding side - you're a well get - lots of luck in love Always Ableing



BEVERLY DRIESSLER
58 Maria St.



LAURIE DYLOFSKY
114 Conkey Ave.



SHELBY ANNE ECKRICH
177 Hartsdale Rd.



CARL JAMES ESLER
80 Peart Ave.



MARGARET LOUISE ESTES
2879 Culver Rd.



BERNARD JUDSON EVERY



MARTHA JANE FAHRNER
187 Dickinson St.



SANDRA JOYCE FALZONE
267 Bennett Ave.



ANGELA ROSE FAMIANO
33 Yates St.



DONALD A. FANTAUZZO
47 Twin Rd.



GARY FEDERATION
264 Klein St.

"Do the feasters

Do the corpulent sleepers sleep?



FRANK RICHARD FEOLA
51 Nichols St.



CHARLES J. FISCHER
32 Farbridge St.

Still be ours the diet hard,

Pioneers!



BETTY JEAN FLOWERS
10 Rhine St.



PATRICIA ANN FRANCE
15 Morton St.



MAUREEN E. FREEDMAN
21 Langham St.



CARL H. FRIEDEMANN
1923 E. Main St.

I could tell you how to get you lots of happiness Heidi



HEIDI FRIEDERICH
450 Avondale Rd.



PETER E. FRIEDES
103 Reliance St.



NORMAN JOSEPH FRISCH
435 Bernard St.



CAROL ANN FURDYN
327 Norton St.

gluttonous feast?

have they lock'd and bolted doors?

*Dear Gene,
I'm glad to
to know you these
past few years.
You've a wonderful
girl and a very
hard worker. Best
of luck in the future.
Love,
Linda*

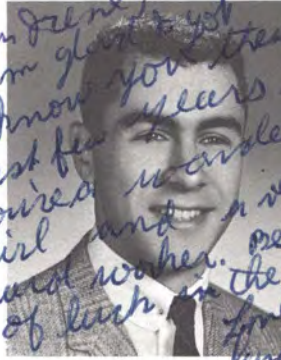

SANFORD I. GALLANT
214 Conkey Ave.



ANNE LOUISE GALLOWAY
1545 St. Paul St.

and the blanket on the ground,

O Pioneers!"



JUDITH BETSY GARTZ
191 Pt. Pleasant Rd.



ROGER C. GARTZ
191 Pt. Pleasant Rd.

Walt Whitman
*Gene, best of luck to
a new gal.
I miss you
and all your
happiness.
Pat*



CAROL A. GATTUSO
3 Lansing St.



PATRICIA ANN GATZ
281 Carter St.



LINDA LEE GEISS
41 Outlook Dr.



CHARLES L. GERHARDT
61 SeaView Ave.



GAIL ANN HEISNER
102 Seacliffe Dr.



BARBARA J. HENRY
89 Nixon Dr.



DONNA JEAN HERINGTON
470 Hudson Ave.



HELEN LOUISE HERRING
127 Grafton St.



NELLY HIRSCH
228 Brookdale Pk.



SUZANNE B. HIRSCH
380 Walzer Rd.



MARILYN SUE HISE
7 Loomis St.



BEVERLY ANN HOESTEREY
39 Randolph St.



GLORIA C. HOGESTYN
35 Brookhaven Ter.



JOYCE ANNE HOLLANDER
40 Avenue D



CHARLES GARY HOLTZ
63 Corley Dr.



DAVID JOSEPH HOOD
5 Abington Rd.



RICHARD ALLAN HOPPE
308 Northland Ave.



CHARLES KEVIN HORTON
310 Winfield Rd.



JENÓ HORVÁTH
8 Evergreen St.



JACQUELINE HOUCHINS
65 Hanover St.

*The Best of
Luck in
the future
Love
Lynn*



WILLIAM ARTHUR HOWIE
175 Bleacker Rd.



JACQUELYN RUTH HUFF
14 Geneva St.



KATHLEEN L. HUGHES
79 Manchester St.

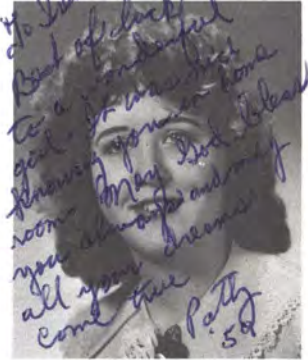

PATRICIA ANN HUGHES
79 Nanchester St.



FLORENCE ANN HURYSZ
70 Lodge Dr.



DAVID BARNEY HYDE
87 Lodge Dr.



MICHAEL G. IWANONKIW
100 Chevalin St.



ALICIA PAUL JACKSON
277 Hudson Ave.



CHARLES A. KINER
38 Argonne St.

We have had a great time at parties and in school here school past
Best of everything



LAWRENCE BEAL KIRCHNER
190 Grafton St.



GARY JAMES KNAPP
77 Aragon Ave.



IRAZETTA KNIGHT
478 Alexander St.



GREGORY M. KOLDAN
156 Dorbeth Rd.

Loads of success
Keep in touch
Love
Gee



NEIL KENT KOMESAR
1964 Clinton Ave. N.

Just favorite
only partner.
I've truly enjoyed
knowing you
Best of everything!
Neil

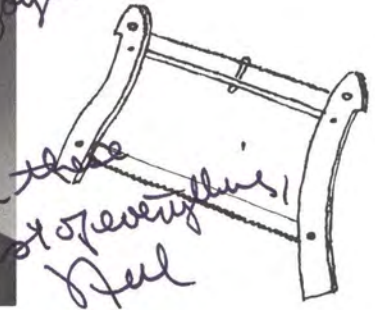

ELAINE ANN KOVACH
238 Fieldwood Dr.

Best of luck to
you
I'll always
love you
and your
family
Love
Elaine

The fun & memories we have piled up since grammar school. It has been a lot of fun since then. I'll always remember you & our good times. Good luck to you, Irene. You deserve the very best. Be good & God bless you



HEIDRUN I. KRAMAR
248 Baden St.



DIANE KRAMER
75 Cuba Pl.

Best of luck to you
I'll always love you
and your family
Love
Diane



CHRISTINE KRASZKIEWICZ
28 Shady Lane Dr.

Love
Christine



LAWRENCE KREITZBERG
230 Versailles Rd.

Best of luck to you
Love
Lawrence



PHILLIP R. KRUSEMARK
207 Walzer Rd.

Best of luck to you
I'll always love you
and your family
Love
Phillip



MIROSLAW KULCZYCKJ
981 Avenue D



GLORIA KAY LaFORCE
770 Helendale Rd.



DONNA GAY LAJOIE
54 Ketchum St.



DONALD T. LAMBERT
63 Northview Ter.



LOUISE D. LAMBERT
74 Northview Ter.



DONNA MAE LANNIN
91 Walnut Pk.

"Till with the sound of trumpet,

how loud and clear



JOSEPH PETER LaPLACA
20 Trelawne Dr.



ALFRED A. LASEK
11½ Gorham St.

Swift! to the head of the army!

Pioneers!



JUDY ANN LAZZARO
40 Claybrook St.



ANTHONY LEBEDYK
106 Mohawk St.



BARBARA ALICE LETKY
182 Herald St.



ANTHONY C. LEVATINO
31 Petrossi Dr.



ELLEN PHILLIPS LIDMAN
75 Dorbeth Rd.



ALICE M. LIND
608 Parsells Ave.

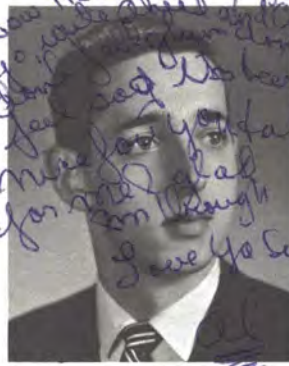

ALLAN LIPPMAN
307 Avenue B



JUDITH ANN LIPSKY
17 Reliance St.

I hope and I'm sure that we far, far off the day break call-hark! we will never lose contact with one another. I know that you will be a success and be happy in everything you do. you're such a terrific girl with a wonderful personality to match. I hear it wind, terrific girl with a wonderful personality to match. May you always have the happiness you deserve. —swift! spring to your places, Here to the best of us & BE ever had.

O Pioneers!"

*Remember me
Dore
Hidy*



JACQUELINE LOMBARDO
108 Lyceum St.



SHIRLEY GRACE LONDON
88 Birchwood Dr.



THOMAS MICHAEL LUPO
400 Culver Pkwy.



OLENA LUPULAK
919 Hudson Ave.

Walt Whitman

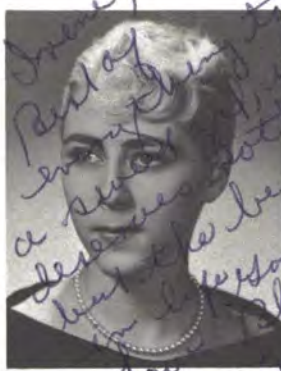

KATHY J. MacCIURG
736 Laurel Hill Rd.



ROSEMARY A. MADDALENA
1392 Clifford Ave.



THEODORA P. MAJEWSKI
100 Cleon St.



GERALD MANIOCI
16 Woodford St.



JOSEPHINE D. MARASCO
1930 Norton St.

Best wishes
to a special friend
I do hope you
knowing
this should
God Bless
you



EILEEN G. MARKUS
9 Hooker St.



MAXINE G. MARKUS
132 Norton St.

There -
see we've
had from this year
never to get the senior
pictures
what a ball! Best
of luck always
to a great girl
Always,
Mary



OKSANA LYDIA MARKUS
67 Zimbrich St.

It's best
to please you
I know
I'll be
always
love



WILLIAM G. MARSHALL
32 Dayton St.

Although we
haven't gotten to
know each other too
well in high school, I'm sure
that the personality that I remember
was had will help you to have a very
successful future. Bill



CAROL ANN MARSZALEK
206 St. Stanislaus St.



MARJORIE INNESS MARTIN
1791 Winton Rd. N.



GEORGE MASS
44 Wilkins St.



FRANCES MARIE MASSARE
1543 Norton St.



SUZANNE E. MASTOWSKI
31 Wadsworth St.



MARIANN MASTRO
190 Nichols St.

Love,
Best of luck
to sweet
Remember
Mariann



MARGARET R. MATRACHISIA
33 Hollister St.



ALLA MATUNOW
943 Whitlock St.



LOUIS JOHN MAZZOLA
655 North St.



JUDITH A. MCGILICUDDY
90 Avondale Rd.



MARGARET ANN MEDYNSKI
76 Pulaski St.



MARJORIE ANN MERKLE
9 Carl St.



BERNARD H. METZGER
55 Avenue C



LINDA JEAN METZGER
12 Gladys St.



MARILYN DOROTHY MEYER
82 Tamarack Dr.



SUE ANN MIKEL
194 Conkey Ave.



BARBARA JEAN MIKIEWICZ
110 Florack St.



JEANETTE MILITELLO
1980 N. Goodman St.



GLENN CHARLES MILLER
1221 Norton St.

Best of luck in the future

Happy New Year... Bless you... Always Marge

I hope you have a really great future... Always Linda

I hope you have a really great future... Always Linda





WAYNE R. MILNE
2327 Norton St.



THOMAS JOSEPH MINARDO
162 Edgeland St.



SHARON LEE MINDNICH
57 Stonehenge Rd.



ANN M. MINGOIA
67 Blakeslee St.

Sharon, I hope to meet you at the beach of Huntington. I don't know your parents' names, but you had a wonderful future ahead of you. Always remember me had times in your life. Love, Ann



THERESA R. A. MIRABELLA
57 Jerold St.

Theresa, I hope you always stay happy and healthy. Love, Ann



PETER J. MISTRETTA
1593 N. Goodman St.

Gene, I wish to meet you in the future. Love, Ann



LINDA M. MOGAB
1972 N. Goodman St.



JEANETTE J. MORREALE
1271 Clifford Ave.



DORLENE AMY MUHS
338 Avondale Rd.



MICHAEL N. NADIAK
17 Maria St.



RONALD DARRYL NASH
28 Ludwig Pk.



ROBERT JAMES NAST
219 Hurstbourne Rd.

I hope to meet you in the future. Love, Ann

Bob, I have been my pleasure to know a girl as nice as you. I hope you mail me. Best wishes, Bob

Turn to P. 85



PATRICIA MARIAN NELLIS
1549 Clinton Ave. N.



LINDA LOU NICKELS
2529 Titus Ave.



MARILYN B. NOLAN
96 Avondale Rd.



JEAN MARIE NOWACK
51 Leo St.



CAROL ANN OBI
731 Sixth St.



GLORIA PATRICIA OKUN
24 DelMonte St.



JONAS OLSOFF
11 Bismark Ter.



JOHN R. OLYER
40 Laser St.



PETER M. PALERMO JR.
50 Gray St.



MARLENE J. PANCHESON
115 Malling Dr.



JAMES FRANK PANEPINTO
178 Spencer Rd.



TOMETA L. PANZARELLA
470 Waring Rd.



SHARON LEE PARSONS
42 Cleveland St.



JUDITH ANN PAULL
40 Rauber St.



JOHN FRANCIS PAYMENT
94 Shore Dr.



KENNETH A. PAYMENT
322 Walzer Rd.

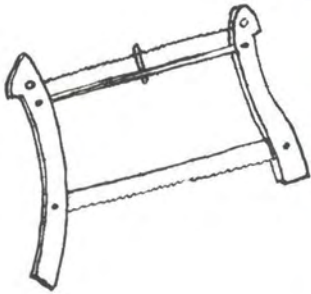

Don



DONALD JOHN PEARCE
35 Nile Dr.



FLORENCE ANN PECORA
1914 N. Goodman St.



MADALINE L. PECORA
85 Jerald St.

*It's sure worth
sunning knowing
such a beautiful
girl as you and I hope
that you won't be so
shy from now on and
give people a kiss when
they give you some gum
also luck
Don*



ANTHONY PAUL PECORARO
148 Lyceum St.



JUDITH L. PELUSIO
174 Dorington Rd.

*Best of you
and accounts of
leave me
care of your
mum Don*



ANTHONY C. PELUSO
167 Blakeslee St.

*It has been
fun having
you on my
team
Always
Love
Don*



MARY ELAINE PELYCHATY
414 Pardee Rd.

*Don't miss the post in love
I wish I had a girl. May you
live a life full of happiness
with sweet
Mary*



NICHOLAS R. PICA
29 Almira St.



JOSEPH ANTHONY PILATO
1570 N. Goodman St.



MARSHA JOYCE PILLAR
1019 Whitlock Rd.



JEAN E. PLANKEN
114 Druid Hill Pk.

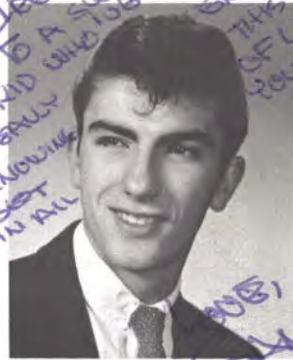

SAM STEPHEN PLATANIA
1504 N. Goodman St.



MARCIA A. PODSIADLY
350 Dunn St.



FRANK R. POLLIFRONE
52 Rustic St.

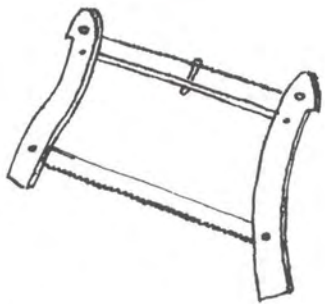

JAMES ROGER POLVINO
83 Hillcrest St.



LARRY ROBERT POPOWYCH
23 Henry St.



JOHN POSATO
9 Fien St.



MARIE E. POSATO
7 Mark St.



IDA A. PRIVITERA
1641 N. Goodman St.



NANCY A. PUKVINO
238 Moulson St.



LAWRENCE E. QUARTERMAN
246 Zuber Rd.



VINCENT RAGGIO JR.
46 Hawkins St.



CHARLOTT M. RECTOR
338 Cascade Pl.



ELISE REMMELI
88 Medfield Dr.



NANCY HELEN RICHMOND
785 Portland Ave.



ANN MARIE RIGGI
198 Martin St.

"For we cannot tarry here,

we must bear the brunt of danger,



NATHAN ROBERT RIVALDO
205 Grafton St.



EMILY S. RIVERA
521 North St.

all the rest on us depend,



LOUIS RIVOLI
201 Marne St.



MILDRED E. RIVOLI
800 Laurelton Rd.



PATRICIA ANN ROCKWELL
25 Stonehenge Rd.



JO ANNE RODGERS
793 Laurelton Rd.

I don't know you for a long time but I know you for a long time. I have a great future.



RICHARD M. SANSONE
30 Grantham Rd.



MARSHALL SARKIS
28 Westchester Ave.

I have a great future. I have a great future. I have a great future.



ANN MARIE SATURNO
9 Norman Dr.

I have a great future. I have a great future. I have a great future.



JUDY DIANNE SAWYER
5 Sheridan St.



MARLENE S. SCALA
180 Bethwood Ave.

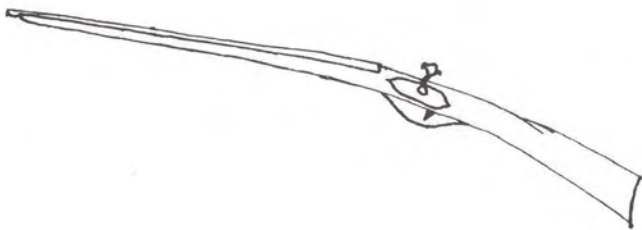

DAVID WALKER SCHANTZ
153 Avondale Rd.

Best girl. I have a great future. I have a great future. I have a great future.



DOMINICK F. SCHIFANO
53 Irondequoit St.



ARTHUR H. SCHMALZBAUER
49 Heberton Rd.



ALBERT THOMAS SCHMITT
219 Cummings St.

I have a great future. I have a great future. I have a great future.



DONALD SCHULTZ
431 Lafayette Rd.



LINDA ELIZABETH SCOTT
144 Dickinson St.



RENEE W. L. SCOTT
25 Herman St.

*Dear Gene,
Best of luck
to a great future.
I hope you
keep your
friendship
always.*

COOL RED
SANFORD G. SEIDE
3 Crosman Ter.



REGINA ANNE SENUTA
597 Wilkins St.

*Gene's luck
Best of luck
from
friends
love
you*



JOSEPH M. SERENO
1 Almira St.



ROBERT WILLIAM SERTH
2495 Titus Ave.



WAYNE A. SHAFER
661 Wilkins St.

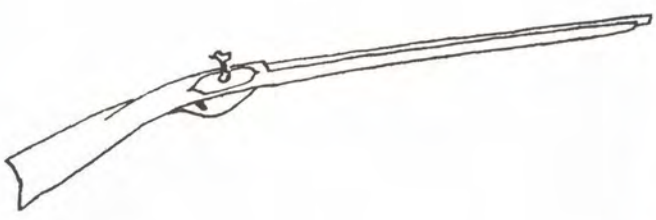

GAIL DIANE SHAFFER
60 Aragon Ave.



DIANE ELKA SHAPIRO
16 Rutledge Dr.

*Best of luck
to a very nice
kid
love
always
Warren*

*I want to wish
you the best of
luck for all
you do out
of life.
We're best friends
for a long time and
I know you will be
a great friend
for a long time.
Good luck
again*



WARREN L. SHAPIRO
109 Harris St.

*Best of luck
to a great future
Gary*



GARY S. SHELDON
146 Hartsdale Rd.



NANCY JEAN SHOPE
44 Cedar Lane

*Best of luck
to a great future
Donald*

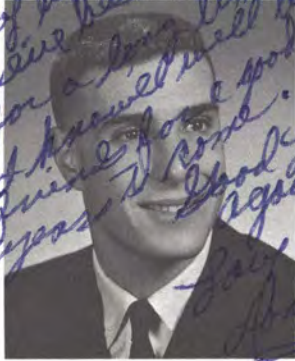

DONALD ALAN SHULMAN
246 Wilkins St.

*Best of luck
to a great future
James*



JAMES MICHAEL SIDOTI
67 Randolph St.



WALTER O. SIEGL
41 Balfour Dr.



ROGER ALAN SIKIERSKI
95 Evergreen St.



DONALD A. SIMON
21 Berlin St.



BONNIE JEAN SLEIGHT
84 Dickinson St.

Dear James I can't tell you how much I love you. I miss you every day. I hope you are doing well. Love, Roger

Now, just a click of to my room. Ma always true. Always Bonnie

Friend, Remember me to your family. Love, Marion



MARION JEAN SMITH
75 Vienna St.



BARBARA ANN SPARKLIN
248 Bleacker Rd.



JOHN TETJE SPITZNAGEL
218 Orland Rd.



WILLARD J. SPROULE
95 Orland Rd.

Just great to hear from you. I've been thinking of you a lot. Always Dick



RICHARD J. STAGLIANO
48 Priscilla St.



DAVID J. STARCK
426 Hoffman Rd.



SUE ANN STARK
790 Melville St.



ROMAN OREST STASIW
134 Hand St.



WILLIAM STAUB
130 Spencer Rd.



EILEEN A. STEIN
4358 Culver Rd.



GERALD FREDERICK STELL
35 Kohlman St.



WILLIAM F. STEPHENSON
91 Thurston Rd.



CHARLES DAVID STERN
27 Hooker St.



ELEANOR MARIE STOLL
98 Bernard St.



ELLEN E. STRICKLAND
67 Walzer Rd.



VALENTINE STRYZACZENKO
19 Renwood St.

It's been a pleasure
knowing you as a class
mate these past few
years. Best of luck in
all of your endeavors.
Larry



ALLEN ROBERT STUBINSKY
95 Hanover St.



LARRY EDWIN SUSSMAN
49 Carthage St.



JANICE MARIE SWEET
46 Reed Pk.



MICHAEL J. SZCZEPANSKI
58 Ernst St.

*Best of luck
in the future,
It's been a wonderful
past year. All the
best!*



CAROLE ANNE SZELES
5 Peckham St.



CAROL ANN TARTAGLIA
461 Lafayette Rd.



PHYLLIS ANN TARTAGLIA
424 Norran Dr.

*Frank,
Best of luck to
a great year. We had
a wonderful year. All
the best!*



ELAINE M. TASCIONE
107 Aurora St.

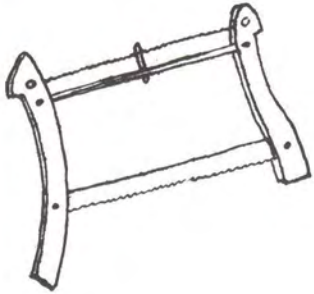

CAROL ANITA TERRACCINE
55 Delamaine Dr.



EDITH A. TERRACCINE
55 Delamaine Dr.



*Best of luck
to a great year!
All the best!*



WILLIAM F. THOMANN
156 Jerold St.



CAROL NANCY THOMPSON
9 Almira St.



PHYLLIS UGLIALORO
132 Midland Ave.



INA M. VIDMANTAS
51 Carter St.



JEAN MAE WALKER
1035 Spencerport Rd.



JOHN DAVID WARNEY
44 Alphonse St.



IRENE YOBAGY
173 Clark Ave.



CAROL ANN YOUNG
237 Martin St.



DONALD J. ZADOROZNY
69 Herald St.



DIANNE CARROL ZALESKI
212 Earl St.



ROCHELLE LOIS ZEIF
87 Conkey Ave.



ADOLF BERNHARD ZUCH
3851 East Ave.

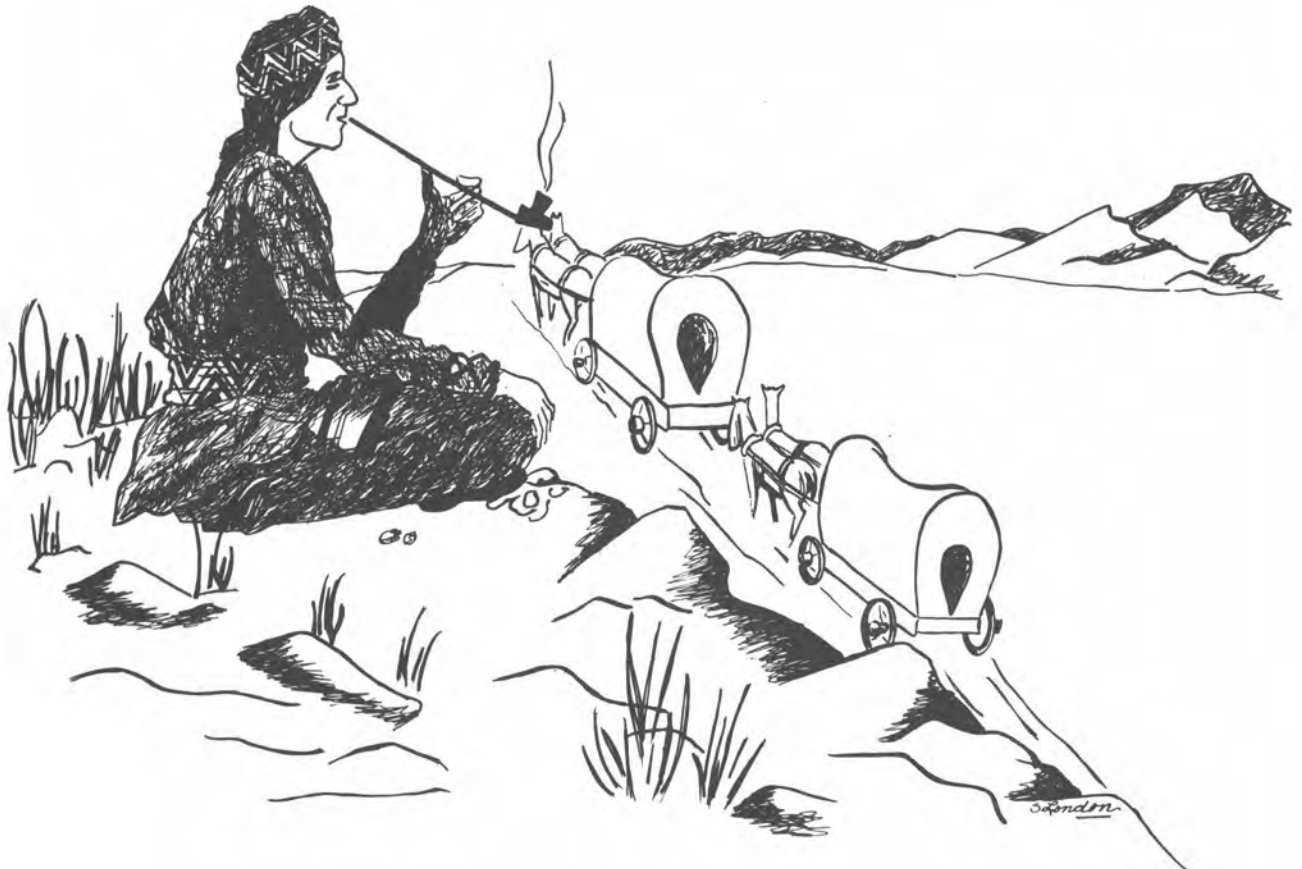

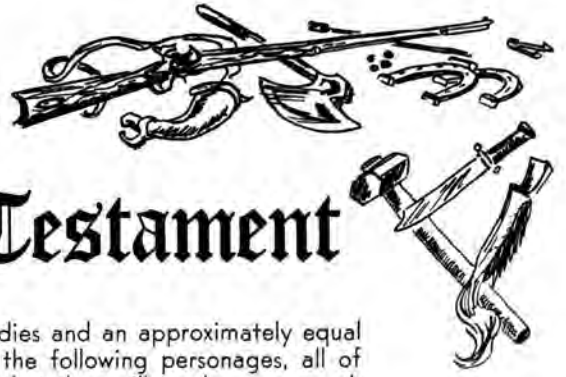

Last Will and Testament

We, the Senior Class of 1959, being of 425 bodies and an approximately equal number of minds, do hereby will and bequeath to the following personages, all of our worldly possessions that we no longer need and that they will surely never need. After due considerations, we submit this, as the twenty-eighth Will and Testament of the graduating classes of Benjamin Franklin High School.

- To Mr. Sabin we leave our heartfelt appreciation for the guidance which he has given us during these most important years of our life.
- To Miss Sullivan we leave our respect for the ideals which she has instilled in us as well as genuine admiration for a warm and generous spirit.
- To Mr. Lowell we leave some seed with which he can plant flowers in the dust on his window sill.
- To Mr. Hawke we leave a press card and some more accelerated seniors.
- To Miss Levin we leave twelve supply teachers and a rubber paper-weight.
- To Mr. Proud we leave an explanation of how a certain group of Seniors managed to have six study halls a day.
- To Miss Rowley we leave a subscription to Reader's Digest so that she may insult our intelligence with it.
- To Mr. McHugh we leave a set of six guns and a copy of the pamphlet, "Go West Young Man!"
- To Mr. Griffith we leave a set of quiet Courant editors.
- To Mr. MacConnell we leave fifty black ties, a bucket of plaid paint, and an extra large mail box.
- To Miss Leene we leave the names of the ten Madison High students whose faces are found in this year's Spirit Committee picture.
- To Mr. Kelly we leave a blank space so that he can fill in his own comment.
- To Mr. Weber and Mrs. Ringwood we leave a copy of Pravda's "Pamphlet on Graduation Gowns" and "Loads of Thanks" for putting up with us.
- To Mrs. Redding we leave a request for several photostatic copies of that beautiful handwriting.
- To Mrs. Hoover we leave a class of Juniors who understand that English is a language and not a method of playing pool.
- To Mr. Iman we leave any book which extols the virtues of "Silent Cal" Coolidge.
- To Mr. Sims we leave a set of compositions on "Why I Shouldn't Chew Gum."
- To Mr. Maurer we leave a box of ant buttons.
- To Miss Bayer we leave a box of collected passes and O.K.ed absence slips.

- To Miss Hess we leave that rare commodity—a Latin scholar who realizes that Plato was the noblest Roman of them all.
- To Mr. Clark we leave a history class which understands that the Constitution has nothing to do with one's health.
- To Mrs. Nicoletti we leave a pet mouse, named John.
- To Mr. Perham we leave two butterfly nets, a magnifying glass, a Basil Rathbone cap, and Rudy Vallee's megaphone for his trips along the Lower Gorge of the Genesee River.
- To Mr. Sherwood we leave the tattered wardrobe of one Ebenezer Scrooge for future use.
- To Miss Martens we leave a lariat and a six-shooter with which to corral that seventh period roundup on Friday afternoons.
- To Mr. Marini we leave a bottle of black hair dye for his "natural gray streak."
- To Mr. Kaplan we leave 359 college applications which have been processed according to the Second Law of Oxidation Reduction.
- To Mr. Hoff we leave a gift certificate for free lessons at Morgan's School of Driving.
- To Mr. Stalker we leave a pound of Maxwell House coffee for his breakfast club.
- To Mr. DeFrancesco we leave a pair of fur-lined gloves for those cold mornings when he has to talk with his hands.
- To Mr. Taylor we leave a small but efficient army of Pinkerton detectives to track down those "lost math books."
- To next year's Eighth Graders we leave a copy of "The Children's Marching Song."
- To this year's Freshmen we leave the remains of their "Freshman Frenzy", 420 bottle caps, 200 Jimmy Rogers records, and one battered room.
- To this year's Sophomore Class we leave a row of lockers which aren't in the basement.
- To next year's Sophomores we leave binoculars for the senior assemblies.
- To this year's Juniors we leave 425 copies of Barron's Review Books.
- To the next Senior Class we bequeath Advanced Chemistry and "Senior Dress-Up Day."
- To Franklin High we leave—but with sorrow.



Duly witnessed and signed this ninth day of the second month of the year of our Lord, nineteen hundred and fifty-nine, by the afore mentioned Seniors. The terms of the document were drawn up by Komesar and Hood so that the Senior Class of 1959 will not be forgotten, and so that their cherished possessions will be enjoyed by those who most richly deserve them, and finally so that this blank page could be filled with a kind of humor that soon, like the Arabs, will silently and mercifully steal away.



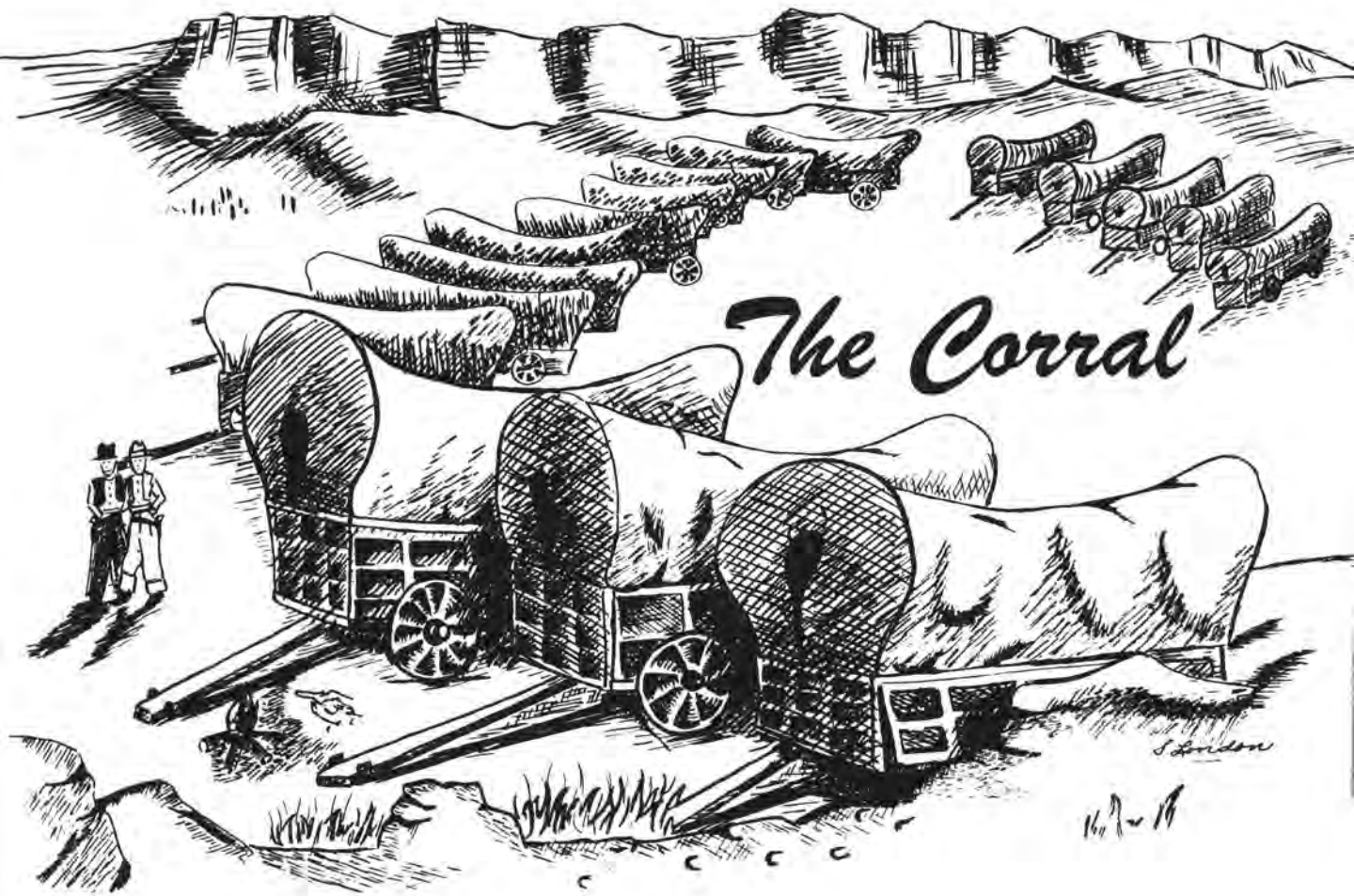

"Corral! Corral!"

Whenever a train stopped for more than a few minutes, it formed itself into a "corral," that is, into an oval or circle. Such a corral was a fortress in itself against the dangers of the wilderness.

And, also, the center of the "corral" was a club room, dance hall, kitchen, and theater for the travelers. At night, after a cessation of the cares of the day, the pioneers watched the friendly flames of the campfire, sang soft grateful ballads, and silently praised God from whom all blessings flow.

In like manner, the students, the settlers of Franklin's fortress, can quietly praise the friendly presence of those extracurricular activities which, like the "corral" of the caravan, have provided them with a restful opportunity not only to sing, play, and socialize, but also to renew their strength and courage for the arduous journey ahead.

Legislative Council



First Row: Miss C. Sullivan, Vice Principal; Mrs. D. Redding; R. Brown, President of Senior House; K. Payment, Vice President of Senior House; Miss T. Leene; Miss D. Martens. **Second Row:** S. Baur, Secretary of Senior House;

A. Chasky, Speaker of Junior House; Mr. J. Lowell, Vice Principal; Mr. M. Ringwood; Mr. C. N. Stalker; S. Rothstein, Recorder of Junior House; R. Shulman, Assistant Speaker of Junior House.

Junior Council



First Row: S. Lisson; F. Corde; K. Abberger; N. Barg; G. Wilkinson; H. Carson; E. Plati; P. Da Vola; B. Paulin. **Second Row:** P. Standish, Boys' Soc. Ch.; S. Spector, Corr. Sec.; C. Abbey, Rec. Sec.; L. Smith, Pres.; R. Guglielmino; N. Adams, Treas.; K. Marciano, Girls' Soc. Ch. **Third Row:** J. Bevacqua; K. Warren, S. Horning; C. Guran; C. Milhouse; G. Napierala; D. MacGregor; P. Flagg; C. Perry; P. Piam-

pino; M. Sachs; P. DiSalvo; C. Christoph; B. Prewasnicak; N. Habes; D. Megi; C. Miller. **Fourth Row:** H. Fine; T. Gravina; P. Miller; J. Byard; R. Tuchrelo; C. Goldman; S. Levison; M. Diodato; S. Passer; P. Demyda; D. Strine; M. Bartikofsky; A. La Marca; G. Roberts; R. De Clerck; D. Schreiber; B. Feldstein.

National Honor Society



First Row: S. Roth; R. Zeif, J. Weinstein, B. Butler, J. Barnash. **Second Row:** E. Bush; J. Lipsky; J. Hollander; G. Okun; N. Hirsch; E. Rummeli; Miss Martens; S. Cherkasky; C. Gattuso. **Third Row:** M. Nolan; A. Lind; M. Martin; I. Vidmantas; M. Iwankiw; D. Cross; N. Komesar; K. Pay-

ment; V. Raggio; A. Lebedyk; D. Hood; T. Pecoraro; J. A. Lazzaro; S. Eckrich; B. Bramer. **Fourth Row:** A. Zuch; H. Friederich; J. Nowack; S. Stark; D. Boers; J. Barker; D. Lambert; H. Casey; R. Stasiw; D. Simon; S. Weinreb; L. DeWitte; E. Hartz; B. Hoesterey; P. Friedes.



Judith Weinstein
Guardian of Flag



Huntley Casey
Standard Bearer



Matin Senzel
Junior Standard Bearer



Maxine Hollander
Junior Guardian of Flag



George Ueoment
Junior Standard Bearer

OFFICERS OF CLASS OF 1961

First Row: B. Corella; Mrs. L. Nofzt, Advisor. **Second Row:** D. Hinchey; Mr. F. Hawke, Advisor; S. Sawyer. **Third Row:** D. Wawrzyniak; A. Kolko.



Sitting: Miss J. Pouliot, Advisor; J. Stekloff; W. Smith; A. Chasky. **Standing:** D. Ordway; Mr. E. Maurer, Advisor; D. Johnson.

OFFICERS OF CLASS OF 1962





Courant

MR. CHARLES GRIFFITH, EDITORIAL ADVISER; MR. RONALD PROUD, BUSINESS ADVISER



Editors

Seated: N. Komesar; J. Barker; L. DeWitte; Mr. C. Griffith, Adviser; J. Weinstein. Standing: P. Friedes; T. Pecoraro; D. Cross; A. Zuch; B. Cavallaro; S. Weinreb; S. Cherkasky; A. Austin.



Business Staff

First Row: Mr. R. Proud, Adviser; S. Wenzler; K. Scarpulla; J. Altavena; N. Tishler; K. Tucker; S. Polmateer; B. Hartman. Second Row: T. Fries; E. Morabito; S. Watson; I. Cresov; C. Nast; J. Ligozio; S. Lynch; S. Taft; A. Bloomberg; S. Rubin; S. Smith; J. Saperstone. Third Row: M. Matrachisia; S. Olyer; J. Lazzaro; L. Schluter; G. Miller; I. Tonchak; J. Billiski; E. Pies; J. Steilloff; B. Shapiro; M. Bartikofsky; P. Cominsky.

"Go West, Young Man" — Horace Greeley



Reporters and Staff

First Row: R. Feldman; M. Kantrowitz; M. Hollander; B. Butler; E. Rummeli; M. Bloom; D. Weingarten; S. Sampler; Mr. Griffith, Advisor. **Second Row:** L. Roehrig; L. Paduchak; J. Balderson; G. Bourdeau; S. Briddon; E. Plati; J. Pine; M. Sharf; E. Turbberg; L. Blair; D. Muhs. **Third Row:** S. Gronsky; D. Shapiro; L. Gibbs; N. Cohen; E. Jaehn; J. Plasso; D. Hood; B. Nast; J. Schaffer; J. Nyenhuis; R. Zeif. **Fourth Row:** H. Fine; L. Nuenhuis; R. Guglielmino; S. Levison; L. Smith; H. Casey; K. Payment; L. Copenhagen; D. Lambert; D. Standish; M. Weir; R. Grossman; M. Levine.

First Row: K. Tucker; T. Kenig; M. Wehren; S. Noyes; Mr. Proud, Advisor; B. Emanuele; R. Shulman; G. Rouso; L. Wilhelm; C. Aceto. **Second Row:** S. Block; K. Abberger; J. Paull; I. Cresov; B. Katerle; B. Corella; S. Rothstein; E. Peck; D. Fogarty; E. Rothstein; M. Flatow; D. Greenberg; J. Montemaro. **Third Row:** M. Cristillo; M. Fiano; F. Corde; T. Mirabella; C. Karweick; D. Megi; N. Habes; S. Hornings; B. Henry; D. Miller; A. Smith; W. Carnell; M. Brown; P. Cuiner. **Fourth Row:** R. Fintushel; T. Fries; D. Shulman; C. Staub; B. Aronow; D. Michlin; G. Skalny; M. Hollander; R. Paulin; L. Cooper; M. Cumbo; P. Weingarten; G. Hackett; R. D'Ambrosio; D. Grossman.

Fifth Row: M. Pellegrino; E. Tascione; P. Snellings; S. Levin; S. Sholman; S. Shapiro; G. Hehir; G. Napierala; B. Prewasnicak; M. Kramer; S. Rubin; D. Weinstein; B. Chichelli; G. Daley; D. Weingarten; J. Jenks. **Sixth Row:** R. Shaver; M. Berg; C. Abbey; J. Schaffer; M. Estes; S. Parsons; E. Plati; B. Faragher; C. Gibbs; A. Galloway; J. Bevacqua; J. Gartz; B. Cavallaro; E. Strickland; S. Greenberg; C. Nast; D. McGuyre. **Seventh Row:** L. Centola; N. Boes; L. Breitschwerdt; E. Gasper; J. Auer; T. Kohler; S. Stark; D. Lambert; L. Copenhagen; A. Brown; J. Hall; P. Atwater; C. Berger; E. Pies; K. Bebemeyer; J. Finkbeiner; A. Sciortino; R. Nast.

G
I
R
L
S
O
R
G
A
N
I
Z
A
T
I
O
N





Larry Chait; John Altavena.

First Row: Joyce Hollander; Neil Komesar; Dave Hood; Elise Rimmeli. **Second Row:** Bonnie Butler; Rochelle Zeif; Marilyn Nolan; Shirley Cherkasky; Barbara Cavallaro; Judy Ann Lazzaro; Heidi Friederich. **Third Row:** Judy Weinstein; Mr. McHugh; Linda DeWitte.

Editors

Photographers



Typists

Elise Rimmeli; Judy Ann Lazzaro; Theresa Mirabella.

Artists

John Ciciotti; Sharon Shapiro; Shirley London; Norman Frisch.





Kneeling: R. Wisotzke; E. Bush. **Sitting:** E. Rimmeli; B. Butler; M. Nolan; J. Lazzaro; D. Muhs; I. Cresov. **Second Row:** S. Mindnich; L. Burns; D. Shulman; J. Lipsky; D. Shapiro; L. Geiss; J. Weinstein; J. Planken; S. Shapiro;

G. Okun; Mr. Proud, Advisor. **Third Row:** M. Scalia; D. Hood; C. Young; R. Nast; G. Miller; R. Atwater; T. Hauss; M. Bentley; H. Friederich; J. Auer; B. Cavallaro.

Business Staff

First Row: I. Cresov; B. Buckler; D. Shapiro; S. Roth; S. Mindnich; R. Zeif. **Second Row:** M. Pillar; L. Geiss; J. Planken; E. Aronow; J. Spitznagel; E. Rimmeli; E. Stein; D. Muhs; Mr. Ronald Proud. **Third Row:** J. Weinstein; D. Hood; D. Cross; B. Cavallaro; M. Matrachisia; J. McGill-

Circulation Staff

icuddy; P. Weingarten; M. Markus; C. Kraszkiewicz; J. Lipsky; S. Eckrich; F. Rubin; E. Cohen; E. Rothstein. **Fourth Row:** L. Sussman; J. Panepinto; S. Stark; L. DeWitte; D. Simon; H. Friederich; S. Weinreb; R. Nast; M. Guerell; J. Auer; L. Grossman; S. Wilson; S. Shapiro.



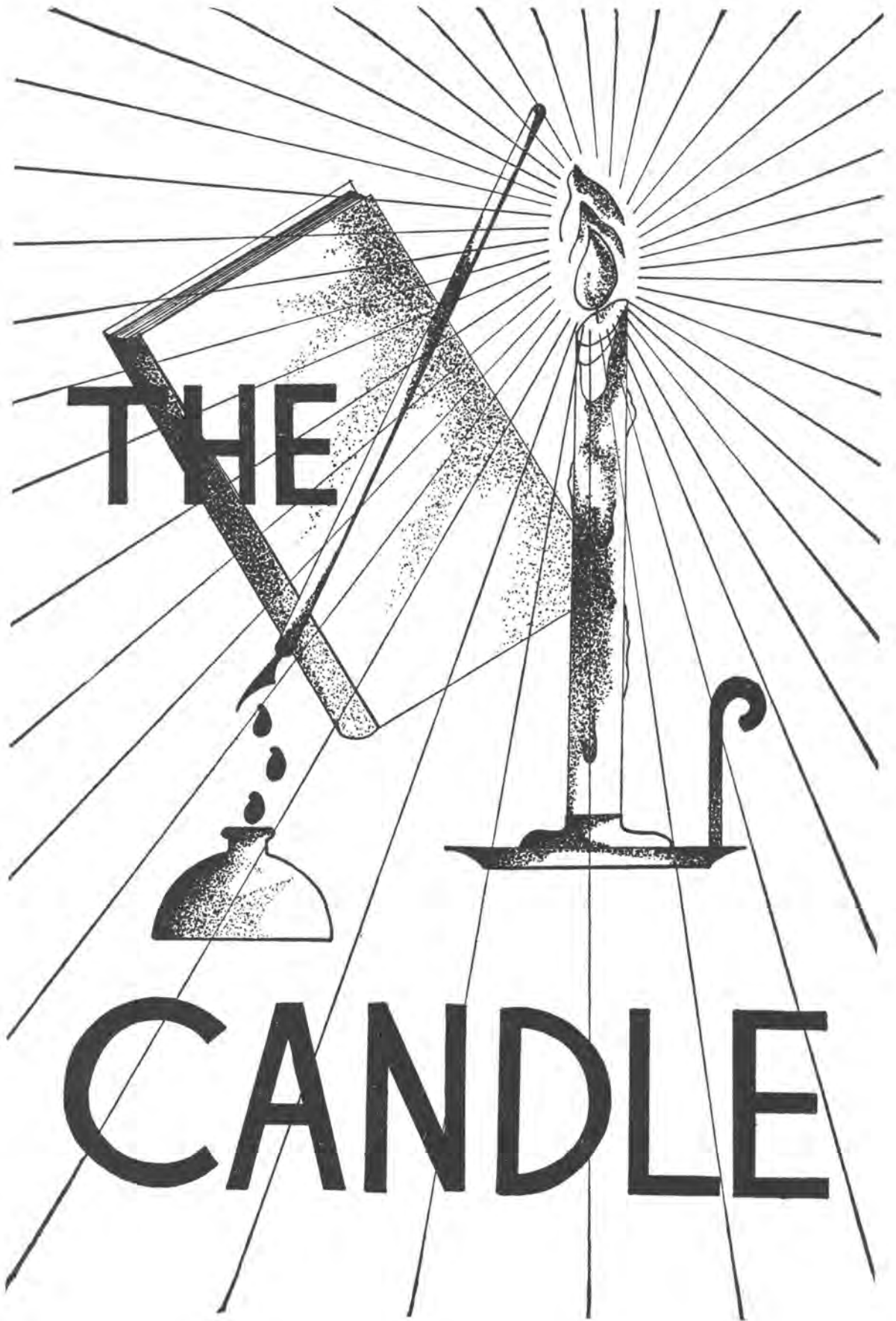

"Foreign Territory"



GROUP I—First Row: L. Crombie; R. Skurski; P. Standish; E. Bush; D. MacGregor; A. Osband; H. Fein; Miss Hess; Advisor; E. Lidman. **Second Row:** N. Barg; S. Roth; B. Lesczinski; L. Aroesty; A. Dubitsky; M. Bloom; C. Culella; M. Baird; S. Gronsky; S. Baur; C. Gattuso. **Third Row:** J. Ligozio; M. Wolff; N. Cohen; A. Kelley; S. Spector; L. Hodge; A. Galloway; M. Nolan J. Pine; W. Roegner; P.

Ammon; R. Krywonos. **Fourth Row:** D. Onderdonk; B. Sparklin; N. Shopes; J. Serafine; S. Alongi; F. Arena; J. Weinstein; J. Olsoff; E. Jaehn; S. Stein; C. Guran; L. Metzger. **Fifth Row:** E. Bonavilla; L. DeWitte; D. Schreiber; G. M. Weiss; P. M. Palermo; R. Weaver; D. Roegner; R. Stasiw; S. Levison; E. Bonavilla, Sr.; G. Mass; C. Goldman; D. Cross.

Latin Honor Society (Optimates)

GROUP II—First Row: P. Goldman; D. Fogarty; L. Cehelsky; Z. Kushner; D. Muhs; D. Lannin; S. Halber; G. Koldan; E. Jacobson. **Second Row:** C. Christoph; E. Rimmeli; M. Doktor; R. Chaskey; K. Kosbab; N. Kiner; B. Bramer; R. Zeif; S. Watesow; V. Stryzaczenco. **Third Row:** A. Sciortino; M. Hubbard; T. Pecoraro; N. Skilling; D. Townson; J.

Niewood; M. Alpert; H. Pok; L. Mott; J. Payment; S. Sawyer; M. Meyer. **Fourth Row:** D. Morse; L. Smith; R. Guglielmino; D. Altman; C. Barned; H. Casey; K. Raday; R. Jensen; S. Weinreb; J. Barker; S. Stark; H. Friederich; B. Yates.



French Honor Society



First Row: N. Weden; P. Insalaco; D. Lannin; J. Rosen; J. J. Barnash; C. Gattuso; B. Butler; G. Okun; K. Abberger.
Second Row: S. Gronsky; L. Hodge; J. Andreano; H. St. Arnaud; T. Kenig; M. Davies; S. Hamilton; Miss Peterson; B. Crosby; M. Flatow; S. Alongi.
Third Row: I. Cresov; E. Cohen; S. Roth; M. Doktor; J. Ades; M. Nolan; R.

Zeif; C. Nast; A. Lind; L. Lipsky; S. Shapiro; A. Galloway; N. Juskiw; G. Bordeau; E. Hryhofenko.
Fourth Row: T. Stepanow; T. Pecoraro; L. Metzger; B. Cavallaro; M. Kusovich; J. Weinstein; I. Avizienis; N. Komesar; J. Sereno; P. Friedes; J. Guarre; H. Friederich; L. DeWitte; E. Hartz; H. Casey.

German Honor Society



First Row: K. Herring; U. Falkner; Miss Peterson, Advisor; C. Gibbs; K. Bebmeyer; J. Raabel; G. Mass; N. Hirsch; A. Stonefield.
Second Row: A. Horeth; S. Mindnich; J. Schafer; J. Palcin; A. Grybauskaitė; J. Planken; M. Kruger; L. Haimerl; E. Faritz; D. Neal; O. Lupular; T. Stepanow.
Third Row: S. Stein; L. Brietschwerdt; D. Hoogendoorn; S.

Ziemiak; L. Berger; B. Lang; G. Harris; J. Auer; L. Gayk; I. Jaehne; M. Benesch; T. Pochunow; C. Sienkiewicz.
Fourth Row: R. Imes; C. Fischer; R. Tuchrelo; T. Kohler; E. Vidmantas; R. Stasiw; R. Raphael; C. Friedemann; A. Zuch; R. Haller; R. Merz; J. Uiard; M. Doliton; R. Schroedel.

Spanish Honor Society



First Row: S. Sampler; M. Rosen; J. Rosen; J. Cherkasky; S. Lisson; S. Cohen; P. Samuel; C. Maxfield; M. Kantroltoitz.
Second Row: Mr. Ronald Masters, Advisor; G. LaForce; M. Aroesty; L. Tabaczynski; E. Epstein; G. Okun; S. Cherkasky; E. Rothstein. **Third Row:** C. Niedzielski; C. Cherkasky; D. Shapiro; M. Martin; J. Lipsky; L. Geiss; S. Rubin; R. Glaess;

V. Weckelman; F. Freedland; E. Morcan; K. Gudas. **Fourth Row:** B. Cavallaro; C. Young; N. Boes; K. Sonneman; K. Steimer; N. Niblack; B. Batjer; K. Epstein; M. Bentley; G. M. Weiss; S. I. Gallant; R. D. Nash; R. Grossman; R. Raphael.

Italian Honor Society



First Row: N. DiBernardo; L. Magin; P. DaVola; A. LaMarca; Mr. D. DeFrancesco, Advisor; M. Diodato; C. LaMendola; E. France; P. Saporito; P. Provenzano; S. Parsons; G. Ferro. **Second Row:** C. Cannava; J. Cascegnio; N. Parrinello; J. Uglialoro; P. Proietti; P. France; M. Chiarello; J. Bevacqua;

D. Trovato; F. Corde; S. Ruggen; G. Gasbarr; M. Ciccarone. **Third Row:** F. Mirabella; J. A. Lezzaro; C. DeBellis; F. Gasbarre; R. Sansone; R. Atlas; B. Peterson; E. Bonavilla; L. Centola; A. Palermo; V. Bellian; R. Salerno.

“Surveyors and Naturalists”



First Row: S. Cohen; G. Pross; S. Lisson; Mr. H. C. Taylor, Advisor; J. Barker; Mr. H. H. Miller, Advisor; P. Samuel; G. Wilkinson; F. Ruffino. **Second Row:** C. Gattuso; S. Baur; M. Aroesty; S. Tanck; K. Sonneman; J. Goldfarb; G. Pugsley; L. Hodge; K. Marciano; B. Butler; S. Cherkasky. **Third Row:** S. Hamilton; J. Ligozio; K. Abberger; C. Nast; L. Bruinsma; A. Stonefield; S. Spector; A. Kelley; J. Bevacqua; H. Carson; M. Morgan. **Fourth Row:** J. Long; S. Ziemniak; L. Berger; R. Skursk; N. Kiner; N. Niblack; B. Batjer; H. Pok; H. Fine; J. Strazzabosco; K. Sperber; T. Pecoraro. **Fifth Row:** J. Weinstein; S. Weinreb; D. Hood; R. Tuchrelo; R. DeClerck; R. Imes; C. Goldman; M. Doliton; D. More; L. Chait; A. Lebedyk; M. Iwankiw; D. Cross; B. Yates. **Sixth Row:** E. Bonavilla; P. Friedes; P. Vonhof; P. Krusemark; R. Grossman; D. Harrison; K. Payment; D. Deckee; H. Casey; R. Stasiw; S. Stark; L. DeWitte; A. Zuch; M. Diodato; R. Merz.

Math-Science Honor Society

"Trail Scouts"



First Row: D. Bozyk; B. Hartman; M. Saporito. **Second Row:** W. Roegner; J. Nyenhuis; B. Kreitzberg; P. Krusemark; M. De John; A. Matunow; J. Schafer; D. Neal. **Third Row:** N. Hirsch; J. Beacham; K. Epstein; T. Pochunow; L. Prociq; C. Barton; R. Sepe; L. Martin; M. Schoener; P. Portnoy; S. Avery.

Main Library Aides



Social Studies Library Aides

First Row: Mrs. Doris Fuller; P. Costa; S. London; B. Weber. **Second Row:** F. Corde; N. Skilling; A. Bartlett; G. Veomett; G. Bach; C. Aceto.



Mrs. Agatha Erwin; K. Valtas; D. Runzo; F. Sadler.

English Bookroom Aides

Attendance Aides

Sitting: A. Prati; J. Huff; Mrs. Eve Litwin; B. Katerle; M. Pellegrino; A. Zizzo. **Standing:** C. Carnell; E. Centola; J. Schafer; I. Jaehne; P. Boscarino; A. Sypian; L. Federation; G. Mistretta; K. DeLorme.



*Send to the
back of the
book of each
semester the
roll in that
order!*

"Along the Overland Trail"



“Folk Ballad Makers”



First Row: Mr. Lyders; L. Wilhelm; J. Welz; J. Sawyer; E. Stein; M. Hise; A. Austin; B. Hartman; R. DeBell; M. Fiano; L. Villard; S. Mindnich; S. Hyman; J. Davidson; Mrs. Bloom. **Second Row:** P. Verrone; S. Quinlan; M. Rumfola; J. DePalma; D. Newkirk; A. Denysenko; M. Osborne; J. Lebea; W. Watson; D. Wilhelm; N. Hirsch; L. Cemhelsky; M. Nolan; B. Strassner; B. Crisciullo; M. Merkley. **Third Row:** P. Azzolino; V. Vassallo; B. Flowers; D. Zievogel; A. M. Riggi; E. Gugino; F. Feola; S. Passer; D. Patton; G. Fallis; M. Bonn; L. Cona; K. MacClurg; J. DeVola; S.

Germuga; D. Jackson; S. Holahan. **Fourth Row:** M. Flatow; M. Migdol; M. A. Refici; S. Mastowski; B. Bramer; C. Terraccine; W. Milhouse; D. Maslanka; J. Krisman; C. Bletzer; J. Kaabel; I. Knight; M. Meyer; M. Bullock; M. A. Bonacci; S. Frelie; S. Tambe. **Fifth Row:** G. Napierala; D. Kramer; P. Ugliarolo; K. Amamski; K. Cooper; J. Nohe; J. Finkbeiner; C. Griffin; B. Hoesterey; N. Richmond; S. Parsons; M. Pancheson; E. Cona; J. McGillicuddy; N. Layton; K. Hughes; C. DeCarlo; M. Estes.

Senior Choir

Ninth Grade Choir



First Row: Mr. Donmoyer; Mrs. Dennison; P. Staccone; C. Valverde; R. Shulman; J. Cogliandro; L. Kerbs; B. Allen; M. Ramsey; A. Blake; D. Johnson; M. Carozza M. Austin; A. Morris; L. Shea; A. DeRomanis; A. Siegel; K. Herring; B. Cuff; S. Raepffel; R. Feldman. **Second Row:** D. Weinstein; L. Blais; M. Hollander; C. Belkin; E. Felder; F. Rumfola; B. Emanuele; L. Baker; E. Epstein; J. Vawdenberohe; J. Simmons; J. Cascegwo; J. Cohen; G. Hackett; M. Graff; M. Brown. **Third Row:** D. Weinstein; A. Pecora; S. Weissman; D. Gallo; J. Sleight; C. Staub; G. Miller; J. Schafer; N. Hafner; K. Areiwaitis; D. Peake; M. Kalil; J. Cerami; T.

Fries; A. Costa; G. Jergrel; J. Alois; J. Rogers. **Fourth Row:** D. Wirth; C. Bachman; C. Smith; S. Livin; M. Rouse; P. Schoeneman; T. Jackson; A. Bostick; T. Pochunow; L. Clements; M. Pinckney; R. Rouse; M. Smith; S. Townsend; G. Mondschein; P. Pata; B. Clark; J. Wesolowski; L. Chase. **Fifth Row:** J. Hranowsky; D. Saperstone; T. Dailor; B. Czas; A. Ciarca; V. Steciw; S. Crino; F. Lentine; R. Korenstein; L. Coakley; P. Myers; R. Peterson; D. Gurecke; T. Guarino; T. Ange; F. Tambe; A. Feldstein; M. Murray; D. Atlas; M. Schoener.



Music Teachers and Accompanists

Mrs. Helen Bloom; Mrs. Grace Dennison; Mr. Kenneth Donmoyer; Mr. Benjamin Scammell; Mr. O. Matthew Lyders.

Junior and Senior Orchestra



First Row: W. Wenzler; S. Sampler; J. Triscari; I. Seifart; A. Austin; S. Lisson; G. Halber; N. Melman; J. Carozza; R. Rubinfeld; A. Levitt. **Second Row:** S. Cravotta; R. Mix; Z. Kushner; M. Korenstein; J. Olsoff; D. Weingarten; P. Winer; S. Spector; Mr. Scammell; A. Galloway; M. Hubbard; E. Swartz; W. Vecchio; S. Briddon; W. Roegner; S. Berger; M. Matula. **Third Row:** L. Bruinsma; S. Stein; T.

Cordaro; J. Szebeda; G. Harris; J. Seafine; A. Swartz; L. Crino; F. Disano; S. Tabar; A. DiPietro; J. Wichman; R. Fintushel; D. Dilulio; N. Cohen. **Fourth Row:** F. Feola; R. Babim; B. Graziano; R. Patzer; R. Imes; R. Haller; F. Gasbarre; G. Kryzaniwsky; M. Mink; P. DeMyda; G. Miller; J. Tinsmon; A. Schewkel; P. Lamagra; F. Pollifrone.

Junior and Senior Band

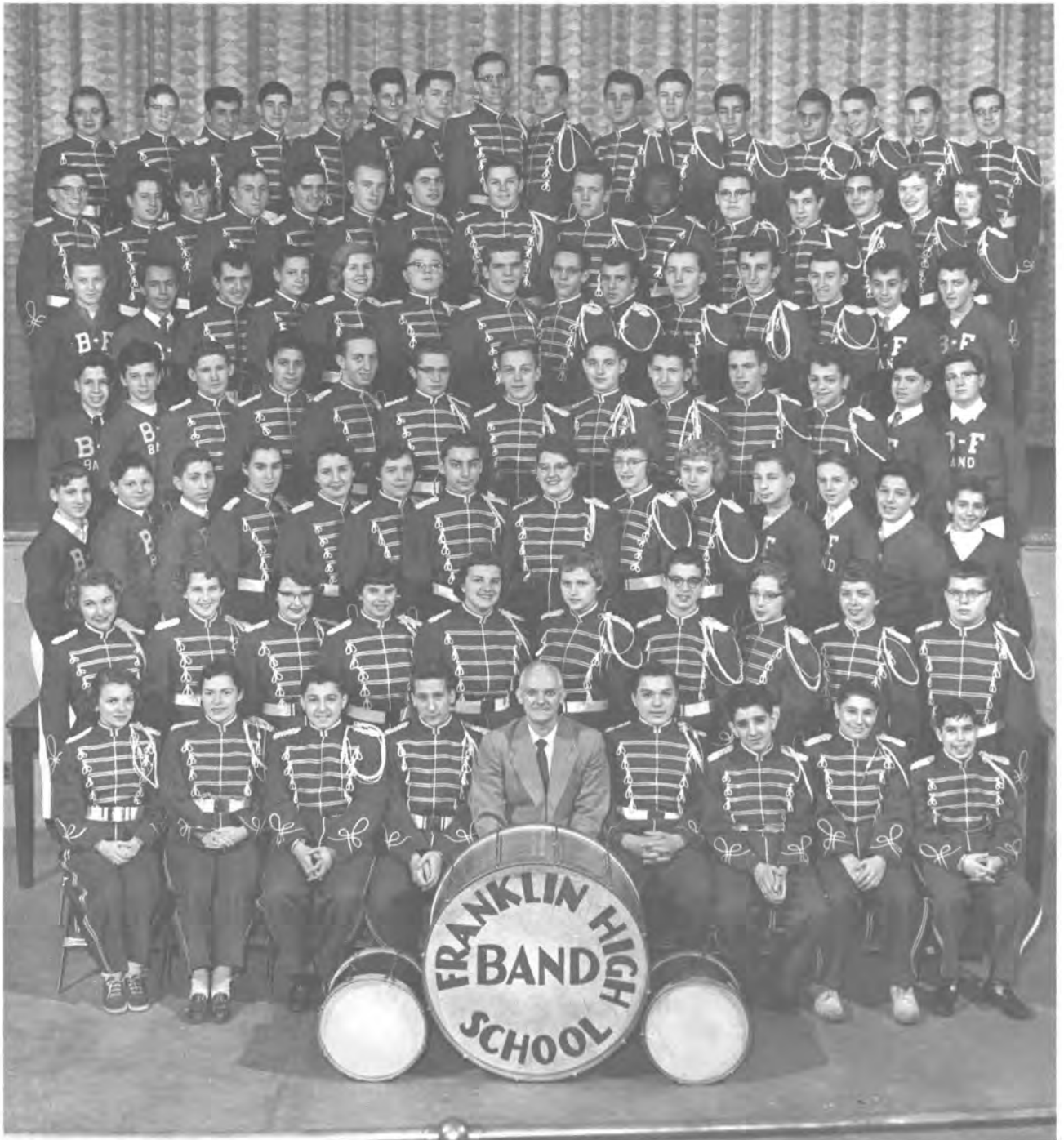

First Row: G. Wilkinson; L. Crombie; S. Halber; R. Debell; Mr. Benjamin Scammell; S. Polmateer; L. Pilato; N. Melman; A. Levitt. **Second Row:** E. Bush; E. Rummeli; R. Ryan; S. Bridson; L. Burns; L. Bruinsma; D. Shulman; S. Baur; D. Muhs; A. Austin. **Third Row:** J. Triscari; M. Matula; T. Cambignet; N. Cohen; L. Geiss; B. Bramer; D. Dilulio; M. Estes; J. Nyenhuis; S. Stein; M. Korenstein; R. Mix; S. Cravotta; C. DeMeco. **Fourth Row:** C. Battaglia; L. Karpowicz; A. Hughes; P. Rivaldo; J. Niewood; J. Herr; D. MacGregor; J. Wichman; J. Serafine; J. Noto; J. Aceto;

W. Vecchio; T. Cordaro. **Fifth Row:** R. Stein; A. Dipietro; A. Angilella; G. Kasky; H. Pok; R. Patzer; A. Schenke; P. Lamagra; G. Frata; G. Harris; J. Pilato; J. Szebeda; F. Pisano; A. Swartz. **Sixth Row:** A. Osband; R. Babin; G. Mascioletti; S. Weinreb; L. Chait; G. Miller; L. Crino; R. Stein; D. Schantz; J. Whitfield; J. Darrer; P. Mistretta; D. Schreiber; L. Nyenhuis; S. Tabak. **Seventh Row:** L. DeWitte; D. Morse; F. Pollifrone; M. Senzel; A. Bartlett; J. Graziano; K. Payment; D. Poegner; J. Salt; J. Bonacci; K. Raday; A. Camarata; F. Feola; R. Haller; C. Tinsman; R. Imes.

Madrigal Club



First Row: Mrs. Helen Bloom; P. Costanza; A. Austin; C. Niedzielski; N. Hirsch; E. Stein. **Second Row:** P. Azzolino; E. Guggino; B. Wilhelm; J. Nohe; W. Watson; T. Fries;

M. Rumfola; B. Hartman. **Third Row:** M. Estes; K. Adamski; M. Bonn; L. DeWitte; D. Patton; D. Roegner; S. Passer; F. Feola; A. Sciortino; J. Finkbeiner; J. McGillicuddy.



Camera Club

First Row: P. Federation; Miss Tuttle, Sponsor; A. Austin; R. Papke; D. Pies. **Second Row:** R. Korenstein; B. Sniderman; S. Collea.

Commercial Honor Society



First Row: A. Prati; L. DeYoung; M. Curatalo; C. Young; Mr. Leon Leggett; T. Majewski; F. Pecora; J. Barnash; K. Allen. **Second Row:** D. Petramalo; C. Karweick; K. Warren;

J. A. Lazzaro; S. Gruber; R. Senuta; G. Heisner; J. Gartz; K. Cooper; T. Panzarella; C. Krajowsky; J. Rodgers.

Cooperative, Office and Secretarial Practice



First Row: J. Lombardo; E. DiClemente; F. Pecora; T. Majewski; E. Kovach. **Second Row:** Mrs. Laura Smith; C. Brooks; M. Freedman; J. Rodgers; C. Karweick; A. Dichiaro;

Miss Eleanor Ratcliffe. **Third Row:** M. Curatalo; J. Pelusio; C. Furdyn; I. Yobbagy; M. Merkle; I. Privitera; B. Gramlich; S. Story; G. Heisner; K. Wurster; C. Rector; R. Senuta.

Guidance Aides

First Row: M. Bloom; K. Yandow; L. Haimerl; P. DaVola; B. Paulin; P. Ahl. **Second Row:** M. Kantrowitz; E. Bush; B. Butler; S. Cherkasky; Miss Rauber; E. Rummeli; G. Okun. **Third Row:** S. Roth; M. Nolan; S. Gronsky; M. Aroesty; H. Carson; M. LeBriton; B. Cohen; P. Uglialoro; S. Parsons; G. Harris; L. Centola; J. Weinstein; L. DeWitte; R. Raphael.



Denise
It has been
swell being in
Sorority & school
with you these past
yrs. Best of luck to
you. The future.
Traffic Squad
Sincerely
Bea Pauli

Coach Roche; W. Scott; M. Murray;
L. Dingfield; E. Rizzo; C. Barton;
B. Dorch; I. White; W. Nathan; M.
Shipp; G. Elliott.

Supply Store Aides

First Row: Mr. L. Leggett; C. Nast; C. Maxfield; R. Comella; S. Cohen; S. Briddon; H. Carson. **Second Row:** S. Tanck; G. Pugsley; T. Panzarella; J. Pelusio; C. Gibbs; A. Matunow; M. Matrachisia; J. McGillicuddy; R. Grossman.



It's coming



First Row: Miss Rauber; G. Harris; S. Mindnich; S. Spector; S. Cherkasky; J. Nowack; P. DeVola; B. Paulin; Mr. Griffith.
Second Row: P. Saporito; S. Cohen; P. Insalaco; M. Kantrowitz; M. Estes; J. McGillicuddy; N. Cohen; L. Aroesty; T. Kenig; M. Aroesty; G. Schwind; S. Wenzler.
Third Row: E. Stein; E. Rothstein; M. Bloom; B. Weber; L. Haimerl; C. Gattuso; S. Moore; L. Burns; S. Gronsky; G. Okun; P. Ahl; M. Baird; R. Comella; A. Dubitsky.
Fourth Row: L. Mott; P. Azzolino; K. Abberger; G. Pugsley; L. Hodge; J.

Dalcin; S. Roth; D. Onderdonk; J. Pine; C. Gibbs; C. Culella; D. Greenberg; L. Cehelsky; L. Lebowitz.
Fifth Row: R. Zeif; B. Cohen; J. Planken; S. Parsons; B. Yates; G. Wildey; B. Faragher; J. Auer; P. Ugliodoro; J. Ugliodoro; L. Geiss; J. Lipsky; K. Yandow.
Sixth Row: S. Eckrich; M. Wollschlegler; K. Adamski; B. Cavallaro; H. Friederich; S. Stark; R. Raphael; D. Roegner; D. Pearce; B. Batjer; L. Centola; J. Weinstein; N. Niblack; C. LaMendola; G. M. Weiss.

Future Teachers of America



Future Nurses of America

First Row: S. Sampler; L. Crombie; F. Hurysz; I. Parsons; P. Milazzo; J. Rosen.
Second Row: E. Stoll; G. Pross; K. Marciano; B. Hoesterey; N. Shopes; H. Pok; J. Dyer; P. Ammon.
Third Row: R. Comella; R. Milbredt; D. Marciano; K. Kosbab; S. Ferretti; J. Guliano; C. Miller; H. Carson; S. Saperstone; T. Mirabella; B. Sullivan; S. Stein.
Fourth Row: B. Skellen; K. Prautzsch; J. Dellefave; M. Duryea; L. Beitschwerdt; B. Conti; M. Behlendorf; D. Zaleski; S. Rogoff; C. Kraszkiewicz; J. Finkbeiner.

"Our Pony Express"



Nurse's Aides

H. Carson; F. Hurysz; Mrs. Shirley Spitz, Nurse; S. Saperstone.



First Row: P. Milazzo; M. Castenni; C. Tartaglia; S. Bonavilla; D. Champagne; J. Caskey. **Second Row:** Miss Martens; B. Callaghan; W. Dick; R. DeMayo; C. Marcinkowski; M. Ferretti; J. Macone; Mrs. Redding. **Third Row:** L. Ulsamer; M. Boas; D. Schmitt; B. Gerow; J. Hogestyn; M. Wickman; E. Strickland; C. Obi; J. Kelly; L. Catlin; K. Bebemeyer; N. Burlay; S. Taft. **Absent:** F. Aloï; F. Corde; E. Tascione; R. Williams; M. Pellegrino; M. Morgan; R. Grossman.

Guides

First Row: A. Stubinsky; R. Elmore; G. Osman; D. MacGregor; W. March; D. Shulman; I. Zwirn; L. Kreitzberg; I. Hubbard. **Second Row:** J. Saperstone; Mr. Charles N. Stalker; M. Alpcot; D. Cross; K. Reed; W. Humphries; R. Schroedel; J. Posato; T. Hasenauer; S. Gerber; J. Spitznagel; A. Lasek. **Third Row:** A. Rosenbloom; D. Schreiber; M. Dolinton; R. Atwater; D. Pirwitz; F. Aman; G. Mass; M. Bent-

Corridor Aides

ley; J. O'Brien; C. Tinsmon; G. Miller; G. Broekhuizen; L. Chait; N. Kiner; E. Jacobson. **Fourth Row:** D. Cuddeback; P. Palermo; J. Evanko; R. Jensen; P. Pryzlock; J. DiGiulio; L. Copenhagen; T. Wilson; T. Harter; T. Hauss; J. Graziano; B. Interlicchia; M. Weir; T. Hall; T. Lupo; G. Weiss; R. Gutkin; P. Goldman.





Radio- Electronics Club

First Row: K. Epstein; J. Dubitsky; M. Doliton; R. Sepe. **Second Row:** Mr. J. Sims; B. Wildman; A. Bloomberg; W. March; P. Pryzlock; J. McConnell; K. Sperber; L. Andrews; S. Slowik.



Visual Aides

First Row: V. Bellian; L. Kreitzberg; R. Fahrer; W. Kind; J. Badura. **Second Row:** B. Kreitzberg; J. Winter; J. Baxter; M. Zeif; M. Gurell; M. Stein; B. Starsky. **Third Row:** T. Harter; T. Hauss; J. Altavena; W. Shapiro; F. Keller; F. Aman; H. Weingarten; R. Atwater; M. Sarkis; M. Goldman; J. Adams; R. Lamagra; D. Nugent.

Stage Crew

First Row: W. Kind; A. Melendy; J. Sweet; K. Bebemeyer; J. Montemaro. **Second Row:** R. Korenstein; R. Atwater; J. Altavena; D. Frisch; R. Shaver.



"Pike's Peak or Bust"



"Fifty-four Forty or Fight"



Junior Varsity

D. Lannin, Capt.; S. Baur; D. Marciano; C. Cherkasky; E. Levy; C. Abbey; C. Christoph; S. Tambe; A. Galloway; S. Smith; S. Parsons.

CHEERLEADERS

Varsity

J. Sawyer, Capt.; N. Adams; M. Hubbard; S. Sawyer; S. Frelrier; J. Gartz; J. Royka; D. Muhs; B. Buckler. Absent: D. Herington.





Majorette Corps

J. Andreano, Capt.; M. A. Bonacci; M. Pitts; M. Morgan; A. Jackson; B. Kastner; J. Baumgart.

Volleyball

First Row: M. Hubka; N. Hoffman; R. Besanceney; S. Watson; J. Mate; D. Newkirk; M. Baumbarger. **Second Row:** Miss Williams; R. Krywonos; M. Sienkiewicz; C. Guran; L. Mubke; O. Vosylius; L. Kueil; C. Sienkiewicz; P. Ahl; C. Haymond.



Badminton

First Row: S. Watson; D. Newkirk; C. Haymond; B. Ulsamer; D. Wood; P. Dunbar; D. Neal; N. Hoffman; J. Mendola. **Second Row:** Miss Rodman; D. Hoogendoorn; K. Valtas; M. Schoener; T. Boenunow; G. Cona; E. Germano; J. Zulauf; L. Janiak; S. Hamilton; O. Krawczuk; R. Krawczuk; L. Cehelsky.



Driver Education

Bowling Action

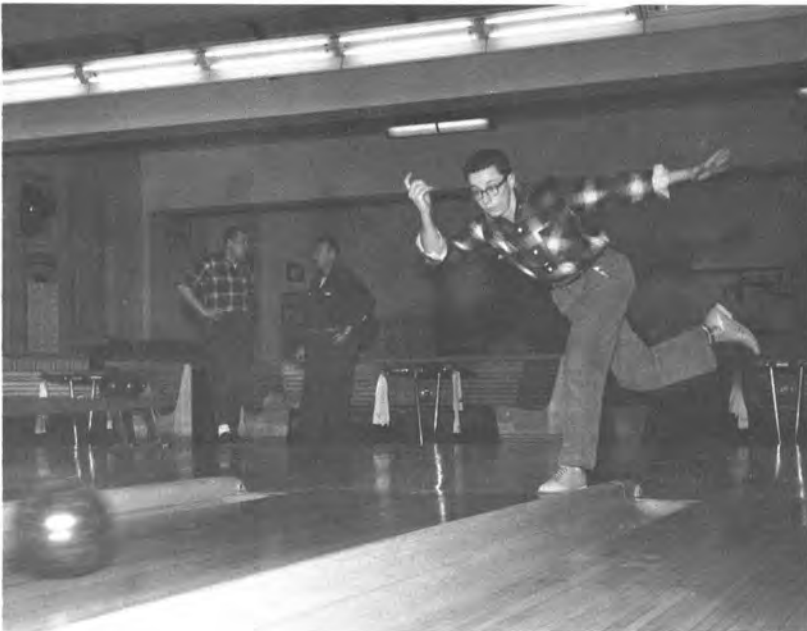

Golf



TEAM—Kneeling: Paul Flagg. **Standing:** Bernard Metzger; Peter Friedes.

Best Photo, Larry
"The Father of Waters"



Swimming Team

First Row: R. DeBell; J. Guarre; M. Alpert; J. Shuman. Second Row: G. Sokolsky; W. Brueckner; G. Komorowski; B. Feldstein. Third Row: Mr. Roche, Coach; M. Berlowitz; M. Cavalcanti; T. Kohler; G. Fallis; A. Schwartz; M. Bentley; D. Hood. Fourth Row: L. Sussman; D. Lambert; P. Quant.



First Row: V. Daniel; S. Sampler; N. Adams; B. Yates; M. Davies; S. Hamilton; Miss Powers; L. McDonell. Second Row: R. Appelbaum; P. Sokolsky; S. Schreder; G. Gasbarre; C. Levatino; L. Pinckney; B. Dixon; Judy Kalish; Joan Kalish; D. Kress. Third Row: J. Montagna; B. DiMeo; S. Briddons; K. Allen; L. Granger; T. Phelps; C. Rosman; Allen; S. Gernoga; J. Blair; R. Comella; L. Blair. Fourth Row: J. Balderon; G. Weckelmann; W. Roegner; L. Tabaczynski; D. Fogarty; J. Komorowski; C. Marton; E. Fritz; C. Minardo; S. Tanck; G. Pugley; J. Nyenhuis; J. Schafer. Fifth Row: P. Kowalchuk; G. Burkunaita; E. Morcan; E. Centola; L. Scott; M. Morgan; J. Andreano; M. Bonacci; S. Michaelson; D. Pancheson; C. Krajowsky; L. Sciacca; L. Redding. Sixth Row: A. Cerami; M. Duryea; J. Unbehaun; K. Adamski; J. Vandenberghe; J. Koehler; M. Pancheson; M. Fahrer; B. Mikiewicz; J. Hogestyn; S. Olyer; S. Smith; C. Christoph; N. Skilling; B. Sullivan.

Girls Aquatic Club

*Irene
 been with
 knowing
 you this
 year. But
 of luck in
 every thing
 you do.
 Sally
 Hamblet*



First Row: Miss Mabel Rodman; J. Mendola; M. Marisi; G. Scorsese; S. Bonavilla; J. Sleight; G. Hackett; P. Sokolsky; E. Bauer; L. McDonell; Miss Edna Snow. **Second Row:** M. Baumbarger; N. Whitney; A. Siegel; S. Markowitz; I. Vilinsky; L. Schluter; P. Johnson; E. Epstein; B. Corella; J. Spallina; D. LaDuke; J. Profeta; D. Johnson. **Third Row:** B. Clark; N. Gabbey; D. Neal; S. Ames; L. Blair; S. Hoesterey; C. Rosman; S. Lane; J. Allen; C. Minardo; P. Dunbar; J. Guiliano; C. Smith. **Fourth Row:** M. Rosensthal; C. Smith; J. Nyenhuis; J. Schafer; D. Kamadula; M. Schoener; J. Hogestyn; L. Nyenhuis; J. Koehler; K. Pravttsch; N. Skilling; L. Sciacca; T. Phelps; M. Rouse; B. Prewasnicak.

Girls' After School Swim Club



Standing: Turner, Tripi, Richane, Singleton, Psalia, DellaVella, Schenkel, Frisenda, Vickers, Mr. Hart.
Kneeling: Wilhelm, Zambito, Shipp, Lauricello, Tranello.

Wrestling Team



Football

First Row: P. Wawrzyniak; S. Sudore; A. Carroll; B. Ashby; H. Scott; R. Irvin; J. Zambuto; R. Hise; S. Simone; W. Harley; J. Jarchowski. **Second Row:** G. Utter; A. Schenkel; F. Fuss; J. Plasso; B. Smith; D. Lehr; J. Barone; H. Jeffries; N. Connors; R. Lettz; D. Starck; T. Graving. **Third Row:** R. Gartz; Mr. R. Brigandi; C. Kelly; V. Alexander; T. J. Jackson; R. Mulla; L. Singleton; C. Waters; E. Evans; N. Griffin; Mr. B. Sullivan; Mr. M. Panaggio. **Fourth Row:** A. Levatino; A. D'Ambrosia; D. DellaVella; A. Mazza; R. Matthews; A. Gustinis; L. Smith; J. Psalia; B. Kelly; R. Serth; T. Perry; C. Johnson.

First Row: D. Lalka; B. Siegl; G. Vidmantis; B. Czas; J. Frillic; L. Karpat. **Second Row:** J. Saperstone; J. Williams; W. Benjamin; M. Sacks; J. McConnel; T. Clarke; B. Haller; F. Malasuskus; J. Vosylius; P. Grebliunas; D. MacGregor. **Third Row:** Mr. Marini, J.V. Coach; P. Osadciw; J. Barker; R. Gartz; D. Pierce; C. Friedmann; D. Weaver; G. Kryzanowsky; A. Staertow; R. Matula; A. Zuch; Mr. Hart, Varsity Coach.

Soccer





Always,
Bob

Tennis

Front: Sanford Gallant. Back: Gary Stern, Sanford Seide, Robert Nast.



Track





Cross Country

Standing: G. Stell; D. Strine; J. Hall; M. Lavine; J. Cahill; R. Guglielmino; J. Baxter; G. Merkel; J. Byard. Sitting: R. Van Neil; S. Ziemniak; I. Hoshowsky; J. Szebeda; A. Alfieri. Kneeling: J. Tinsmon; R. Glaess; Coach Graf.



Baseball 1959

Standing: Mr. W. Graf; A. Knutowicz; T. Gravina; T. Clarke; J. Plasso; G. Monje; J. Williams; A. Cappadonia; R. Leetz; D. DellaVella. Kneeling: A. Mazza; G. Chapmon; E. Bonavilla; T. Brightman; R. Cappellino; R. Gartz; G. Stell.



**Varsity
Basketball**

First Row: Coach Panaggio; A. Potter; P. Grebliunas; G. Monje; R. Irvin; B. Bethea; T. Dent.
Second Row: R. Mink; J. Galbraith; C. Hatcher; J. Stell; L. Smith; T. Jackson.



**Reserve
Basketball**

First Row: M. Lavine; B. Chess; K. Reed; C. Kelly; B. Slater; H. Jeffries; J. Huffman. Second Row: Coach Sullivan; N. Griffin; E. Evans; J. Hall; A. Gustinis; D. Lee; R. Washington; W. Smith; R. Hise.



Kappa Theta Chi

First Row: W. Roegner; A. Tuchrelo; M. Neu; R. Comella; C. Calcagno. **Second Row:** L. Nitschke; K. Kosbab; M. Baird; S. Taff; L. Breitschwerdt; D. Marciano; B. Corella. **Third Row:** L. Centola; D. Kasky; C. Griffin; V. Osinski; L. Gayk; M. Duryea; S. Sawyer; M. Bullock; N. Klein; F. Sangermano; J. Uglialoro; M. Bagnara. **Absent:** J. Kucy.



First Row: T. Pavia; J. Mendola; D. Wood. **Second Row:** B. Cavalier; E. Germanow; P. Dunbar.

Sigma Chi

*Best of luck in your future years.
"Sigma" "n"
July '66*



Kneeling: L. Metzger; L. Burns; C. Gattuso; B. Buckler; D. Lannin; J. Sawyer; R. Wisotzke; S. Germuga. **Sitting:** L. DeWitte; H. Friederich; D. Muhs; B. Butler; S. Mindnich; E. Stein. **Standing:**

Alpha



Omega Beta Phi

First Row: J. Balperson; K. Abbegger; J. Manicone; B. Crisciullo; J. Smith; R. Milbredt; P. Samuel; N. Tishler; C. Maxfield. **Second Row:** G. Weckelman; B. Kastner; B. Prewasnicak; K. Sonnemank; N. Barg; M. DiPrima; K. Salzer. **Third Row:** P. Johnson; J. Billiski; J. Unbehaun; D. Hoogendoorn; J. Finkbeiner; M. Rosenthal; C. Gibbs; B. Crosby; A. Kelley; B. Sullivan; B. Kierecki; J. Turner; P. Ammon.

TEENS

Delta Sigma Phi

Kneeling: W. Milne; C. DiPrima. **Second Row:** G. Koldan; W. Siegl; N. Pica. **Third Row:** M. Iwankiw; A. Lebedyk; A. Zuch; C. Fischer; J. Guarre; R. Siekierski; D. Hoppe.



S. Stark; B. Mikiewicz; J. Auer; N. Boes; J. McGillicuddy; M. Matrachisia; B. Cavallaro; M. Meyer; J. Planken; B. Bramer; A. Galloway; L. Geiss.



First Row: J. Graziano; D. Priest; G. Fallis; R. Jensen; R. Richane. **Second Row:** T. Kohler; H. Hall; B. Interlicchia; D. Hinchey; D. Wawrzyniak.

Beta Chi

Sigma Rho Kappa

First Row: A. Stonefield; E. DeCamilla. **Second Row:** W. Fox; D. Frisch; G. Licata. **Third Row:** C. LaMendola; A. LaMarca; L. Nuci; M. Diodato.

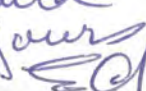

It has been my pleasure knowing you and I wish you all the luck in the world. Yours



Zeta Kappa Chi

First Row: F. Tambe; J. Allen; J. Caskey; P. Federation; K. Kreiwaitis. Second Row: J. Guiliano; K. Prautzsch; C. Gravina; M. Ramsey.

Alpha Omega

First Row: R. Guglielmino; J. Tinsmon; R. Weaver; L. Smith. Second Row: D. Flagg; J. Byard; D. Strine; J. Hall.



Theta Beta Phi

First Row: G. Wilkinson; K. Marciano; B. Strassner; S. Baur; L. Crombie. Second Row: M. Lomoglio; D. Cangialosi; C. Christoph; M. Davies; S. Simon; K. Tucker; S. Tanck; N. Adams; G. Schwind; L. Wilhelm; K. Delorme. Third Row: J. Ligozio; D. Onderdonk; G. Pugsley; J. Royka; J. Bevacqua; S. Smith; C. Guran; B. Faragher; N. Buerman; S. Stein; S. Tambe; P. Rossi; E. Plati; S. Hamilton; L. Hodge; S. Ames; R. Ryan. Absent: C. Abbey.





First Row: M. Merkley; J. Montemaro; S. Lisson; G. Wilkinson; V. Weckelman; J. Sawyer; E. Stein; K. Payment; Miss T. Leene, Advisor; S. Baur; B. Strassner; D. Quine; J. Balderson; L. Wilhelm; K. Delorme; B. Szarlacki. **Second Row:** M. DiPrima; J. Altauena; D. Lannin; N. Tishler; P. Samuel; K. Tucker; B. Butler; P. Ammon; W. Rowgner; E. Levy; B. DiMeo; A. Tuschrelo; B. Katelle; P. Insalaco; S. Rothstein; J. Pine; S. Mindrich; L. DeYoung; G. Schwind; P. DeVola; B. Paulin. **Third Row:** D. Marciano; D. Greenberg; S. Gronsky; S. Freedland; G. Reinhardt; J. Ligozio; J. Huff; B. Buckler; J. Schafer; J. Nyenhuis; D. Muhs; M. Nolan; K. Kosbab; M. Flatow; J. Goldfarb; M. Aroesty; L. Burns; K. Marciano; N. Adams. **Fourth Row:** P. Rossi; S. Tambe; S. Frelie; R. Faragher; A. Galloway; J. Lipsky;

S. Eckrich; J. Royka; J. Bevacqua; C. Nast; S. Spector; S. Hamilton; E. Plati; E. Onderdonk; L. Geiss L. Metzger; S. Sawyer; C. Christoph; S. Smith; L. Nickels; L. Bruinsma. **Fifth Row:** M. Duryea; A. Coleman; S. Gruber; I. Tonchale; D. Hoppe; M. Hubbard; J. Gartz; J. Manicone; B. Yates; N. Niblack; M. Wollschleger; H. Friederich; M. Davies; C. Gibbs; E. Peck; W. Campbell; J. Billiski; L. Nyenhuis; A. Bonlce; B. Sullivan; K. Cooper. **Sixth Row:** B. Batjer; P. Flag; F. Arena; D. Hood; T. Gravina; J. Guarre; J. Tinsmon; A. Schwartz; L. Smith; D. Boers; J. Panepinto; P. Pryzlock; J. Hall; E. Bonavilla; D. Strine; S. Levison; G. Miller; M. Sachs; N. Braveman; C. LaMendola; P. Johnson.

Spirit Committee



Sitting: H. Friederich; J. Hall; L. DeWitte. **Standing:** J. Guarre; C. Christoph; G. Schwind.

Franklin Inter-Club Council

Senior Banquet





*Christmas Play,
Christmas Scenes
1958*



"For Hire — SENIORS

Have Diploma

Will Travel"



12-1 MR. WEBER



12-2 MISS CALLAHAN



12-7 MR. MARINI



12-4 MR. FRASCA



12-8 MR. CRANE



12-5 MR. GULLO



12-9 MRS. SHERMAN



12-17 MRS. FRASER



12-21 MR. MILLS



12-18 MRS. RINGWOOD



12-24 MR. QUINN



12-19 MR. HAWKE



12-25 MR. MAURER



12-20 MR. SIMS



12-26 MISS POULIOT

*Well come to
on end. I now say
goodbye with
goodrow
Always*

The Traders

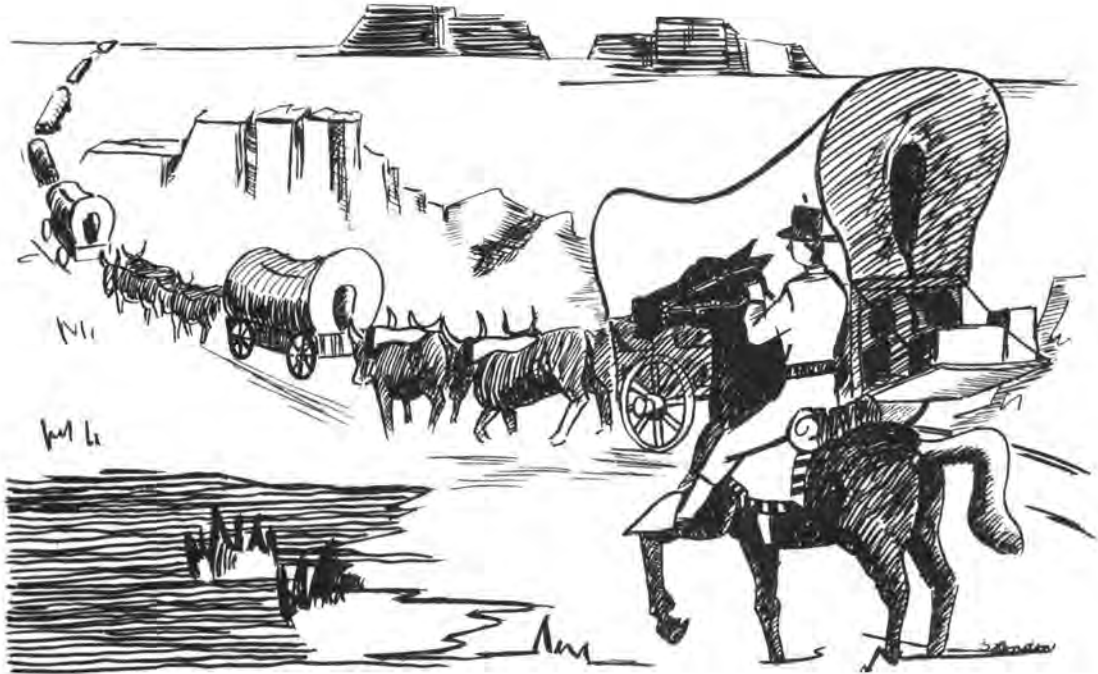

"Catch Up! Catch Up!"

Riding the trail was difficult work, especially at the end of the caravan's column. For here along with the other dangers of the trail were the ever-present clouds of choking dust, which brought to the traders of the freight wagon sore eyes, inflamed throats, and premature death.

Often carrying colt revolvers, these gallant merchants and "bullwhackers", who were in charge of all supplies, chuck tables, and provisions of the train, were invariably strong, young, and well-armed. Moreover, they were pledged to adhere to a strict moral code, for each agreed—"not to use profane language, not to treat animals cruelly, and not to do anything that is incompatible with the conduct of a gentleman."

Our advertisers, like the traders of the chuckwagon, are all strong, gentlemanly, and well-armed with the kind of sterling services and ample provisions which have made our 1959 KEY journey to the Old West a possible success.

*Remember me!
Sincerely,
Joseph
P. Patrick
11/60*

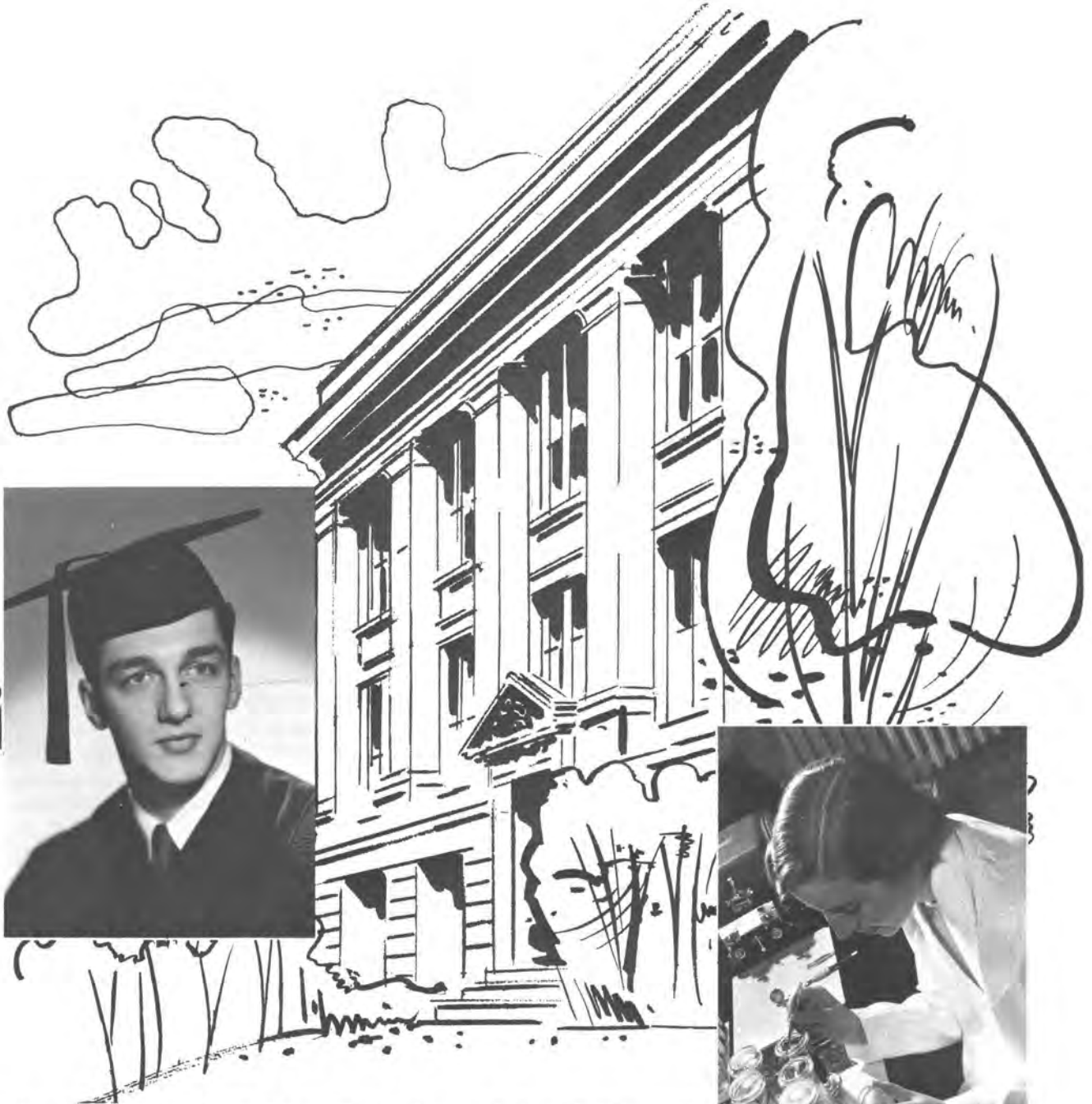

Photographs . . . The Heart of Your Yearbook . . . priceless school memories
live in photography by Varden.



VARDEN STUDIOS, INC.
YOUR OFFICIAL YEARBOOK PHOTOGRAPHERS

YEARBOOK DIVISION

28 South Union Street • Rochester 7, New York

96

A. FRIEDERICH & SONS CO.

GENERAL CONTRACTORS

Established 1870

Builders of Benjamin Franklin High School

710 LAKE AVE.

GLEN. 3-0011

Good Luck & Best Wishes
You are a great Law student
Lorale
2/10

I hope that someday you
look back here & read what I
wrote you. We had a blast
for 4 years + a lot of fights. A hope
that you gain in my class's hope
& my God bless you. Good luck

*Congratulations
To All
Graduates*

NOLAN'S PARTY SUPPLIES

1919 Main Street East

Our Biggest Bargain!

ELECTRIC AND GAS SERVICE

Because nothing does so much at such little cost, day in, day out, electricity and gas continue to be the biggest bargain in your family budget.

ROCHESTER GAS AND ELECTRIC

VIM GYMNASIUM AND ATHLETIC CLUB

101 Ridge Rd. W. at Lake Ave.

Hours: Mon. Thru Fri.
12:00 Noon til 10:00 P.M.
Sat. 10 A.M. - 6 P.M.

"Ask Your Buddy, he's a member"



BOTTLED UNDER AUTHORITY OF THE COCA-COLA COMPANY BY

COOL CHEVROLET

NEW CAR SALES

Used Car Sales and Service

360 Culver Rd. BRowning 1-7070

Compliments of

TISHLER DRUGS

1166 North Goodman, Corner of Clifford
Hubbard 2-4978

Compliments of

ROCHESTER BAKERY

1252 N. Goodman St.

EDW. BROCKMAN'S SONS

FLORISTS

Wedding Bouquets and
Flowers for All Occasions

1955 Ridge Rd. E. HOpkins 7-9625

Compliments of

**MATHEOS BROS.
ICE CREAM CO.**

Distributors of
Fine
Ice Cream

*

Spencerport, N. Y.

*Best of
luck. Dad & I
of fun with you
this year
Buyer prob. 08*

**THURSTON
HANDICRAFT
CLEANERS**



Corner Norton & North
Hopkins 7-1241

**Be a
Telephone
Girl!**



You'll be smart if you look now into the possibilities of a job as a Telephone Operator after graduation. See your Vocational Guidance Counselor or visit our Women's Employment Office for more information about these opportunities.

MONDAY THROUGH FRIDAY
8:30 A.M. to 5:00 P.M.

NEW YORK TELEPHONE COMPANY

95 N. Fitzhugh St.
Rochester, N. Y.

Patronize the

**BENJAMIN FRANKLIN
SUPPLY STORE**

for
QUALITY and ECONOMY

A Full Line
of
School Supplies

Compliments of

**GIFTVILLE - CAMERAVILLE
DIVISION**

Home of Rochester's Fastest Growing
Photo Dept.

902 Bay St.

BUtler 8-6440

The Comptometer School

CLASSES—Morning, Afternoon, and Evenings
TUITION—Complete cost, including books and sup-
plies, \$150. Payable in easy installments.

PLACEMENT—Free placement service to all COMP-
TOMETER graduates.

OFFICIAL—The ONLY official COMPTOMETER
SCHOOL in Rochester, owned and operated by
the Comptometer Division, Felt & Tarrant Mfg. Co.

LOCATION
325 Burke Bldg., 5 St. Paul Street, Rochester 4, N. Y.
Phone: BAker 5-6003 Thos. B. Lloyd, Mgr.

Compliments of

FRIED CAKE HOUSE

Culver at Norton

Ridge Crest Radio & Television, Inc.

SALES - SERVICE

All Sales Backed By Our Service Department

HOplins 7-5473

2008 Ridge Rd., E.

Rochester 22, N. Y.

EVERYBODY EATS AT

EDDIE'S CORNER

1193 Hudson Ave.

COngress 6-9854

"Rochester's Most Modern Tux Shop"

JAY-CEE CLEANERS & TUX SHOP

500 Joseph Ave.

BAker 5-3233

Make the Occasion - Buy Flowers
at

NAVIS FLORAL SHOP

Specializing in
Corsages and Wedding Bouquets

1378 Norton St.

HOplins 7-8927

(North Park Shopping Center)

Member of F. T. D.

OXFORD PRESS

EFFECTIVE PRINTING

Church and School Publications
Wedding Invitations

901 Monroe Ave.

BRowing 1-5400

Compliments of

TOWN TAXI

LOcust 2-4400

CAREFUL, COURTEOUS SERVICE

Compliments of

SMITH-CORONA

137 East Ave.

SMALLINE'S PHARMACY

(The Corner Drug Store)

Clinton Ave. No. and Ridge Rd. East
Phone COngress 6-8250 - 6-9791

THE QUALITY BAKERY

There's No Substitute for Quality

687 Joseph Ave.

BAker 5-5910

Planning your future?

SAVE for it
at R.S.B.



Marriage . . . college . . . whatever your plans are for after graduation, start saving NOW for the big day. Make regular deposits in a School Savings Account at Rochester Savings Bank. It's quick and easy. Just ask your homeroom teacher for an R.S.B. deposit card, fill it out, return it with your deposit, and that's it! Save something *every* banking day! Generous interest dividends are added to your account twice a year.



BANKING COMMITTEE



Mr. Benjamin Lipson; G. Heisner; J. Lazzaro.

*Sincerely,
& Good Luck
Ben Lippson*

*Nice having you sit
in front of me in am. H.S.
Best of luck in future
years*
JO STEN'S
*Manufacturers of
CLASS JEWELRY & **Carl Hill***

COMMENCEMENT ANNOUNCEMENTS

Represented by

ROBERT E. KILLIP

+

105 Laney Road
Rochester 20, N. Y.

Compliments of

LESCHORN BROS. GAS STATION

3000 Culver Rd.

TANYA'S

Wedding Invitations - Wedding Photo Albums

HOplins 7-5856

1504 N. Goodman St. Rochester 9, N. Y.

LESNIAK'S MARKET

645 Norton St.

COngress 6-9582

Compliments of

WALLACK'S PHARMACY

1727 N. Clinton Ave.

BEALE BOWLING CENTER

4306 Culver Rd.

COngress 6-9659

MANDELL'S PHARMACY

Portland at Norton

HOplins 7-0785

HOplins 7-0879

Compliments of

Carl Vogt's Meat Market

174 Pt. Pleasant Rd.

Compliments of

**PENLON-MASURY PAINT
& HARDWARE STORE**

371 Pearl Ave.

CHASE DRUGS

PRESCRIPTION SPECIALISTS

219 Conkey Ave.

COngress 6-8660

COngress 6-9735

MACKAY'S JEWELERS

72 Irondequoit Plaza

Rochester 17, N. Y.

BOND ROOFING CO.

284 Pearl St.

GREENfield 3-5116

FREE ESTIMATES

Sam's Light Hauling & Moving

LOCAL & LONG DISTANCE MOVING
Specializing in Piano Moving

183 Ashwood Drive
LOcust 2-7787

Rochester 9, N. Y.

**Northside Construction
Co., Inc.**

40 Lafayette Rd.

BUtler 8-5687

HOpkins 7-5116

BLESS DRUG STORE

856 Joseph Ave.

HAmlton 6-7881

BON JON'S

TUXEDOS - RENTAL and SALES

700 Clinton Ave. N.

BAker 5-1558

AUTOGRAPHS

*Best of luck
to you in your
future. May you
succeed in everything
you attempt to do.
Love Betty*

*Best wishes
always to a
great gal +
a tremendous
personality.
Be good
Love
Vi*

*I know you
mean all your
goals you want
to get. Love
Janet
(Andy's cousin)*

*Best of luck in the
future to a real
gal. It's been nice
knowing you.
Laurice*

Have a nice
Summer and Good
Luck in the future.
It been a bad
proving you this year.
Julie Roman

Best of Luck
Always, May success
always be with you.
Good luck next year.
Jo Ann
(60)

Don't forget to write me next
year and other years I'm away.

Love is Luck Always,
Sandy

Remember me

Love you
Ellie

Love always
"Ellie"
Ellie
